



GS1100 Series

Unmanaged Gigabit Ethernet Switch

Version 1.00
Edition 3, 06/2012

User's Guide

IMPORTANT!

READ CAREFULLY BEFORE USE.

KEEP THIS GUIDE FOR FUTURE REFERENCE.

Screenshots and graphics in this book may differ slightly from your product due to differences in your product firmware or your computer operating system. Every effort has been made to ensure that the information in this manual is accurate.

Table of Contents

Table of Contents	3
Chapter 1	
Getting to Know Your Switch.....	5
1.1 Introduction	5
1.2 Features	6
1.3 Applications	6
1.3.1 Standalone Workgroup	6
1.3.2 Bridging	7
1.4 Power Over Ethernet (PoE)	7
Chapter 2	
Hardware Description and Connection	9
2.1 Rear Panel	9
2.1.1 Rear Panel Power Connection	9
2.2 Front Panel	9
2.2.1 RJ-45 Auto-negotiating Ports	10
2.2.2 IEEE 802.3az EEE	10
2.2.3 Mini-GBIC Slots (GS1100-24 Only)	10
2.2.4 Front Panel Connections	12
2.2.5 Front Panel LEDs	12
2.3 Hardware Installation	13
2.3.1 Wall Mounting	14
2.3.2 Rack Mounting	14
2.3.3 Mounting the Switch on a Rack	15
Chapter 3	
Troubleshooting.....	17
3.1 Improper Network Cabling and Topology	18
Appendix A Legal Information.....	19
Index	21

Getting to Know Your Switch

1.1 Introduction

This chapter describes the key features, benefits and applications of your Switch.

This User's Guide covers the following models: GS1100-8HP, GS1100-16, and GS1100-24. The Switch is a 10/100/1000 Mbps multi-port switch that can be used to build high-performance switched workgroup networks. The Switch is a store-and-forward device that offers low latency for high-speed networking. The Switch is designed for workgroups, departments or backbone computing environments for small businesses.

Table 1 GS1100 Series Comparison Table

PORT/SWITCH DETAILS	GS1100-8HP	GS1100-16	GS1100-24
8 10/100/1000Base-T Ethernet ports (including 4 PoE ports)	✓		
16 10/100/1000Base-T Ethernet ports		✓	
24 10/100/1000Base-T Ethernet ports			✓
2 mini-GBIC (SFP) slots			✓
One physical IEEE 802.3az ON/OFF button	✓		
One power ON/OFF switch	✓	✓	

The GS1100-8HP has four GbE PoE ports that can supply power to the connected PoE powered devices.

The GS1100-24 has two mini-GBIC ports for uplink connection. Use mini-GBIC transceivers in these slots for connections to backbone Ethernet switches.

The Switch has a built-in algorithm that automatically assigns priority to received packets. It can operate in low power idle mode in compliance with IEEE 802.3az Energy Efficient Ethernet (EEE).

Figure 1 Front Panel**GS1100-8HP****GS1100-16****GS1100-24**

1.2 Features

The following are the essential features of the Switch.

- Conforms to IEEE 802.3, 802.3u, 802.3ab and 802.3x standards.
- Auto-negotiating 10/100/1000 Mbps Gigabit Ethernet (GbE) RJ-45 ports.
- Auto-sensing crossover for all 10/100/1000 Mbps Gigabit Ethernet (GbE) RJ-45 ports.
- Supports N-Way protocol for speed (10/100/1000 Mbps) and duplex mode (Half/Full) auto-detection.
- Supports store-and-forward switching.
- Supports automatic address learning.
- Supports IEEE 802.3az EEE
- Support IEEE 802.3af and IEEE 802.3at PoE standards (only GS1100-8HP)
- Full wire speed forwarding rate.
- Supports 802.1p CoS.
- Embedded 8K MAC address table providing 8000 MAC addresses entries.

1.3 Applications

This section provides two network topology examples in which the Switch is used.

1.3.1 Standalone Workgroup

In this application, the Switch is an ideal solution for small networks where rapid growth can be expected in the near future.

The Switch can be used standalone for a group of heavy traffic users. You can connect computers directly to the Switch's port or connect other switches to the Switch.

In this example, all computers can share high-speed applications on the server. To expand the network, simply add more networking devices such as switches, routers, computers, print servers etc.

Figure 2 Standalone Workgroup Example

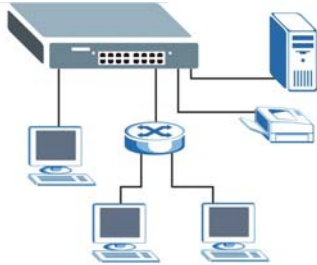

1.3.2 Bridging

With its large address table and high performance, the Switch is an ideal solution for department networks to connect to the corporate backbone or for connecting network segments.

The following figure depicts a typical segment bridge application of the Switch in an enterprise environment. The two networks (**RD** and **Sales**), the standalone server and the computers can all communicate with each other and share all network resources.

Figure 3 Bridging Example

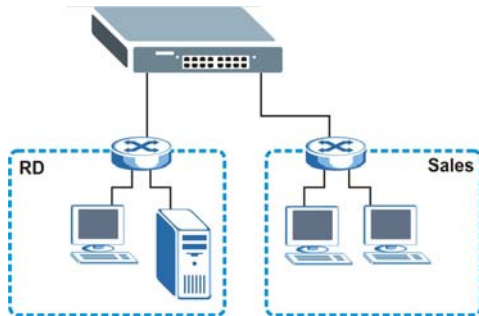

1.4 Power Over Ethernet (PoE)

The PoE function is available for GS1100-8HP only.

Ports 1 to 4 on the GS1100-8HP are IEEE 802.3at High Power over Ethernet (PoE) compliant and can supply power of up to 30W per Ethernet port.

A powered device (PD) is a device such as an access point or a switch, that supports PoE (Power over Ethernet) so that it can receive power from another device through a 10/100/1000 Mbps Ethernet port.

In the figure below, the IP camera and IP phone get their power directly from the Switch. Aside from minimizing the need for cables and wires, PoE removes the hassle of trying to find a nearby electric outlet to power up devices.

Figure 4 Powered Device Examples

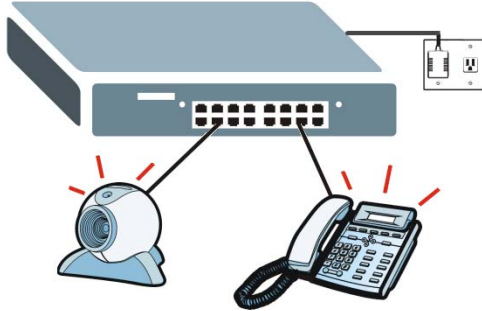

Hardware Description and Connection

2.1 Rear Panel

The three-pronged power receptacle is located on the rear panel of the Switch. Refer to the power supply requirements on the panel.

Figure 5 Rear Panel

GS1100-8HP



GS1100-16



GS1100-24

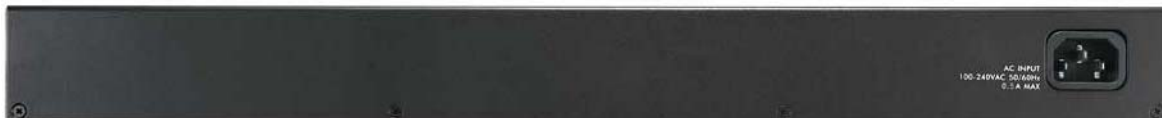

2.1.1 Rear Panel Power Connection

Connect one end of the supplied power cord to the power receptacle on the back of the Switch and the other end to the appropriate power source.

For the GS1100-8HP and GS1100-16, use the **POWER ON/OFF** switch to have the Switch power on or off.

2.2 Front Panel

The front panel of the Switch includes the auto-negotiating 10 Base-T/100 Base-TX/1000 Base-T RJ-45 ports and the LEDs.

The GS1100-24 has two mini-GBIC ports. Refer to [Section 2.2.3 on page 10](#) for more information.

2.2.1 RJ-45 Auto-negotiating Ports

The 10 Base-T/100 Base-TX/1000 Base-T RJ-45 ports are auto-negotiating and auto-crossover.

An auto-negotiating port can detect and adjust to the optimum Ethernet speed (10/100/1000 Mbps) and duplex mode (full duplex or half duplex) of the connected device.

An auto-crossover (auto-MDI/MDI-X) port automatically works with a straight-through or crossover Ethernet cable.

2.2.2 IEEE 802.3az EEE

The Switch supports the IEEE 802.3az EEE (Energy Efficient Ethernet) standard to help reduce power consumption. This allows the Switch to go into power saving mode and switch off part of receive and transmit circuitry when it is not transmitting or receiving data through an Ethernet connection.

An EEE-enabled device initiates Low Power Idle (LPI) signals to negotiate and wake up the remote device when there is data to be transmitted. To use EEE, both devices should be EEE compliant.

EEE is configured on a per-system basis in the Switch. If one of the networking devices that connect to the Switch doesn't support EEE, EEE may not work in the Switch to save power.

The EEE feature is enabled by default on the GS1100-16 and GS1100-24. Press in the **IEEE 802.3az EEE ON/OFF** button on the GS1100-8HP front panel to turn on the EEE feature. Disable it if the remote side doesn't support it or you don't want the network performance to be impacted due to the latency from the additional time required for the sleep and wake transition.

2.2.3 Mini-GBIC Slots (GS1100-24 Only)

These are slots for mini-GBIC (Gigabit Interface Converter) transceivers. A transceiver is a single unit that houses a transmitter and a receiver. The Switch does not come with transceivers. You must use transceivers that comply with the Small Form-factor Pluggable (SFP) Transceiver MultiSource Agreement (MSA). See the SFF committee's INF-8074i specification Rev 1.0 for details.

You can change transceivers while the Switch is operating. You can use different transceivers to connect to Ethernet switches with different types of fiber-optic or even copper cable connectors.

To avoid possible eye injury, do not look into an operating fiber-optic module's connectors.

- Type: SFP connection interface
- Connection speed: 1 Gigabit per second (Gbps)

2.2.3.1 Transceiver Installation

Use the following steps to install a mini-GBIC transceiver (SFP module).

- 1 Insert the transceiver into the slot with the exposed section of PCB board facing down.
- 2 Press the transceiver firmly until it clicks into place.

- 3 The Switch automatically detects the installed transceiver. Check the LEDs to verify that it is functioning properly.
- 4 Close the transceiver's latch (latch styles vary).
- 5 Connect the fiber optic cables to the transceiver.

Figure 6 Transceiver Installation Example

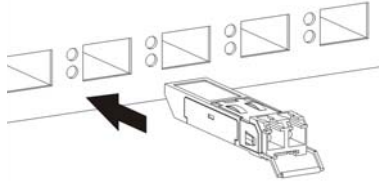
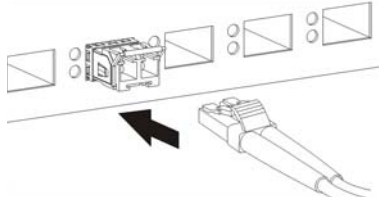

Figure 7 Connecting the Fiber Optic Cables



2.2.3.2 Transceiver Removal

Use the following steps to remove a mini-GBIC transceiver (SFP module).

- 1 Remove the fiber optic cables from the transceiver.
- 2 Open the transceiver's latch (latch styles vary).
- 3 Pull the transceiver out of the slot.

Figure 8 Removing the Fiber Optic Cables

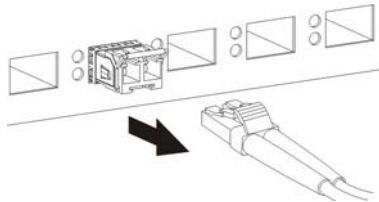

Figure 9 Opening the Transceiver's Latch Example

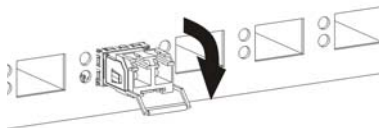
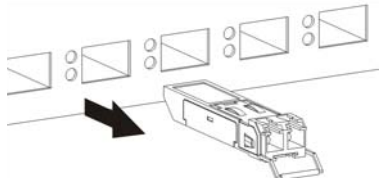

Figure 10 Transceiver Removal Example



2.2.4 Front Panel Connections

You can use unshielded twisted pair (UTP) or shielded twisted-pair (STP) Ethernet cables for RJ-45 ports. The following table describes the types of network cable used for the different connection speeds. .

Table 2 Network Cable Types

SPEED	NETWORK CABLE TYPE
10 Mbps	Category 3, 4 or 5 UTP/STP
100 Mbps	Category 5 UTP/STP
1000 Mbps	Category 5e, 6 UTP/STP

You can use either crossover or straight-through cables for all the ports.

2.2.5 Front Panel LEDs

The LED Indicators give real-time information about the status of the Switch. The following table provides descriptions of the LEDs.

Figure 11 Front Panel LEDs

GS1100-8HP



GS1100-16

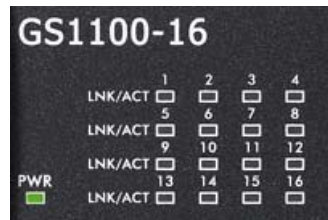

GS1100-24



The following table describes the LEDs.

Table 3 The Front Panel LED Descriptions

LED	COLOR	STATUS	DESCRIPTION
PWR	Green	On	The Switch is on and receiving power.
		Off	The Switch is not receiving power.
PoE MAX	Red	On	Power supplied to the PoE port(s) reaches the power budget limit or exceeds the total PoE power budget on the Switch.
		Off	Power supplied to the PoE port(s) is below the power budget limit.
PoE	Amber	On	Power is supplied to the PoE port.
		Off	Power is not supplied to the PoE port.
LINK/ ACT	Green	On	The port is connected to an Ethernet network.
		Blinking	The port is receiving or transmitting data.
		Off	The port is not connected to an Ethernet network.
1G 10/100	Green	On	The port is connected to an Ethernet network at 1000M speed.
		Blinking	The port is receiving or transmitting data at 1000M speed.
	Amber	On	The port is connected to an Ethernet network at 10M or 100M speed.
		Blinking	The port is receiving or transmitting data at 10M or 100M speed.
		Off	The port is not connected to an Ethernet network.

2.3 Hardware Installation

See the following table for a comparison of the hardware installation methods of each GS1100 model:

Table 4 GS1100 Series Installation Comparison Table

MODEL FEATURE	GS1100-8HP	GS1100-16	GS1100-24
Desktop Device	✓	✓	
Wall-mountable	✓	✓	
Rack-mountable		✓	✓

Note: Ask an authorized technician to attach the Switch to the rack/wall.

For GS1100-8HP and GS1100-16, you can place the Switch directly on top of your desk or have it wall-mounted. For GS1100-16 and GS110-24, the size is suitable for rack-mounting and you can refer to [Section 2.3.2 on page 14](#) for instruction. Take note of the following:

- The Switch should have a minimum 25 mm space around it for ventilation.
- The Switch should be placed in a desk that has a level surface and that is able to support the weight of the Switch.

To start using it, simply connect the power cables and turn on the Switch.

2.3.1 Wall Mounting

Do the following to attach your Switch to a wall.

See [Table 5 on page 14](#) for how far apart to place the screws.

Table 5 Distance between the centers of the holes for wall mounting

MODEL	DISTANCE
GS1100-8HP	120 mm
GS1100-16	150 mm

- 1 Screw the two screws provided with your Switch into the wall (see the figure in step 2). Use screws with 6 mm ~ 8 mm (0.24" ~ 0.31") wide heads. Do not screw the screws all the way in to the wall; leave a small gap between the head of the screw and the wall.

The gap must be big enough for the screw heads to slide into the screw slots and the connection cables to run down the back of the Switch.

Note: Make sure the screws are securely fixed to the wall and strong enough to hold the weight of the Switch with the connection cables.

- 2 Align the holes on the back of the Switch with the screws on the wall. Hang the Switch on the screws.

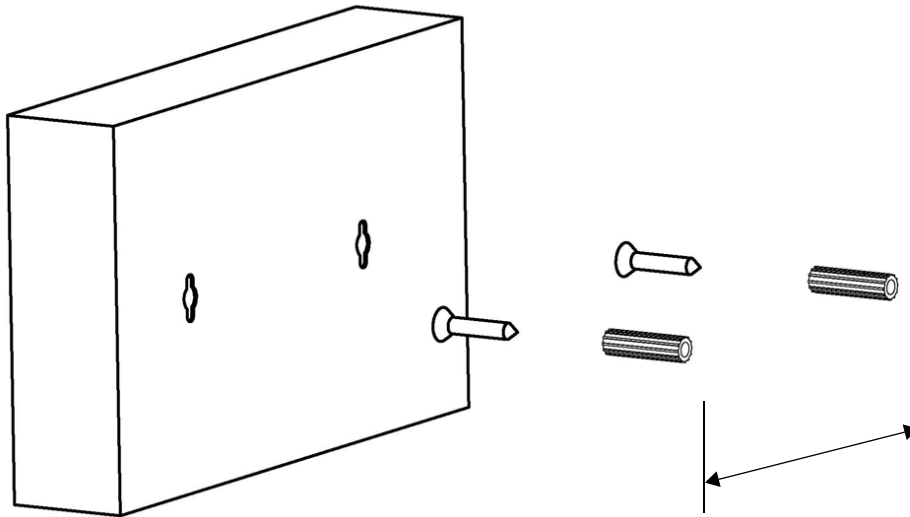

The Switch should be wall-mounted horizontally. The Switch's side panels with ventilation slots should not be facing up or down as this position is less safe.

2.3.2 Rack Mounting

The Switch can be mounted on an EIA standard size, 19-inch rack or in a wiring closet with other equipment. Follow the steps below to mount your Switch on a standard EIA rack using a rack-mounting kit.

Rack-mounted Installation Requirements

- Two mounting brackets.
- Eight M3 flat head screws and a #2 Philips screwdriver.
- Four M5 flat head screws and a #2 Philips screwdriver.

Failure to use the proper screws may damage the unit.

Precautions

- Make sure the rack will safely support the combined weight of all the equipment it contains.
- Make sure the position of the Switch does not make the rack unstable or top-heavy. Take all necessary precautions to anchor the rack securely before installing the unit.

Attaching the Mounting Brackets to the Switch

- 1 Position a mounting bracket on one side of the Switch, lining up the four screw holes on the bracket with the screw holes on the side of the Switch.

Figure 12 Attaching the Mounting Brackets (GS1100-16)

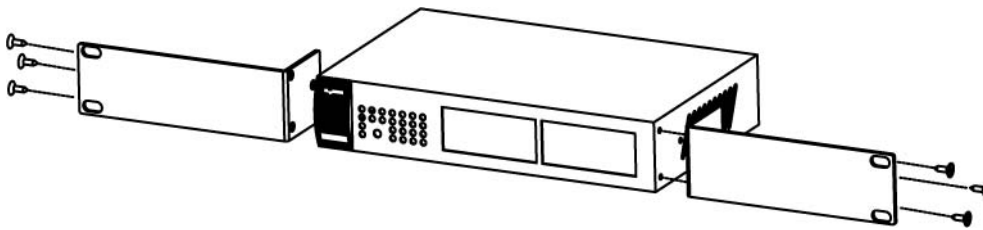
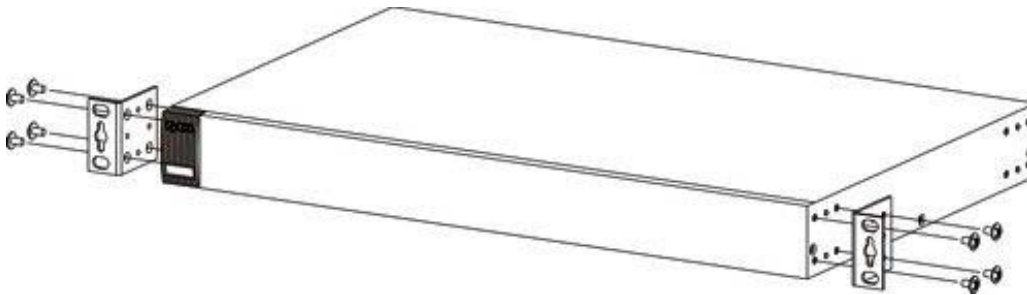

Figure 13 Attaching the Mounting Brackets (GS1100-24)



- 2 Using a #2 Philips screwdriver, install the M3 flat head screws through the mounting bracket holes into the Switch.
- 3 Repeat steps 1 and 2 to install the second mounting bracket on the other side of the Switch.
- 4 You may now mount the Switch on a rack. Proceed to the next section.

2.3.3 Mounting the Switch on a Rack

- 1 Position a mounting bracket (that is already attached to the Switch) on one side of the rack, lining up the two screw holes on the bracket with the screw holes on the side of the rack.

Figure 14 Mounting the Switch on a Rack (GS1100-16)

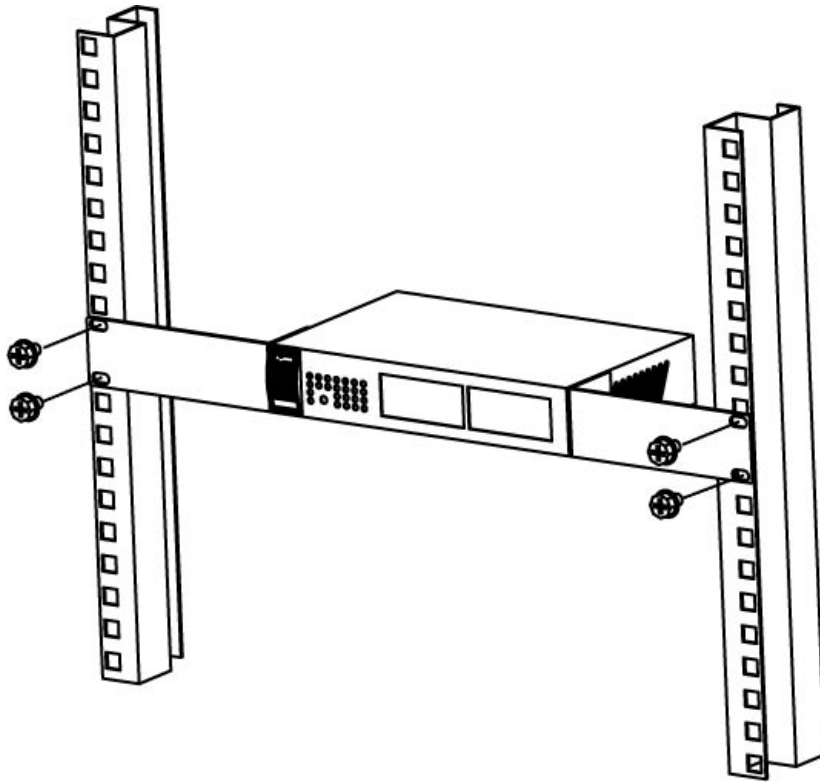
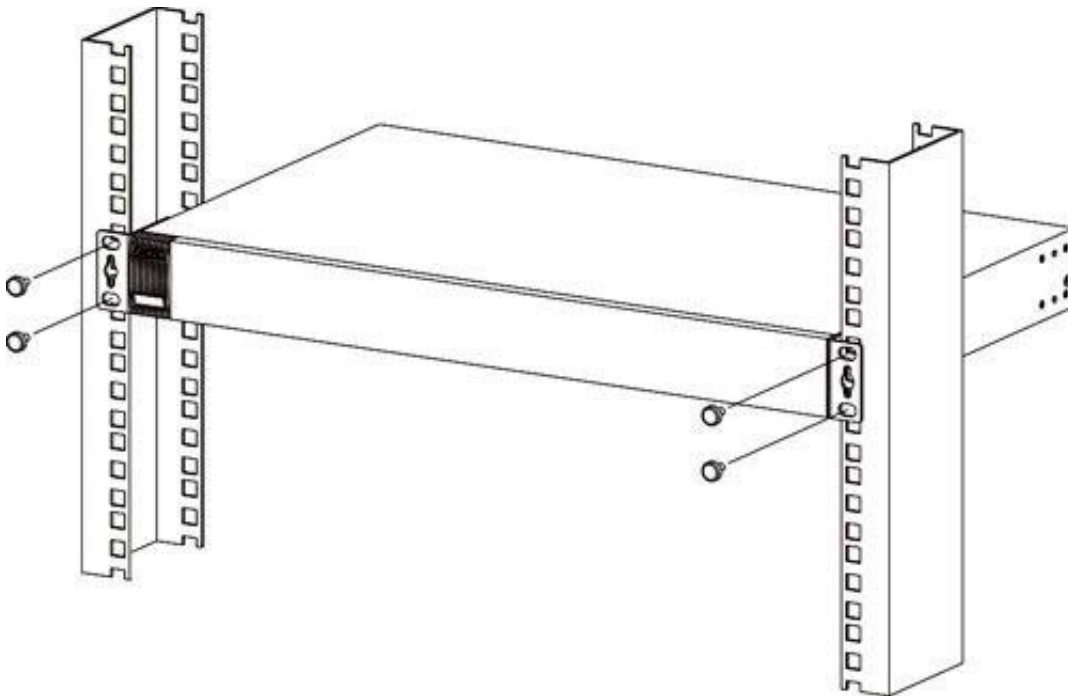

Figure 15 Mounting the Switch on a Rack (GS1100-24)



- 2 Using a #2 Philips screwdriver, install the M5 flat head screws through the mounting bracket holes into the rack.
- 3 Repeat steps 1 and 2 to attach the second mounting bracket on the other side of the rack.

Troubleshooting

This section describes common problems you may encounter with the Switch and possible solutions.

Troubleshoot the Switch using the LEDs to detect problems.

The **PWR** LED on the front panel does not light up.

- Check the connections from your Switch to the power source. Make sure you are using the supplied power cord and that you are using an appropriate power source. Refer to the product specifications.
- Make sure the power source is turned on and that the Switch is receiving sufficient power.
- If these steps fail to correct the problem, contact your local distributor for assistance.

The **LINK/ACT** LED does not light up when a device is connected.

- Verify that the attached device(s) is turned on and properly connected to your Switch.
- Make sure the network adapters are working on the attached devices.
- Verify that proper network cable type is used and its length does not exceed 100 meters. For more information on network cable types, see [Section 3.1 on page 18](#).

The **PWR** LED is off and/or power is not being supplied to my PoE-enabled device. (For GS1100-8HP)

- Check to see that the power cord is securely connected to the GS1100-8HP and an appropriate power source. Make sure the power source is on and functioning properly.
- Check that the Ethernet cables are connected properly and that you are using the correct type of Ethernet cable. Contact your local distributor if the problem persists.

3.1 Improper Network Cabling and Topology

Improper network cabling or topology setup is a common cause of poor network performance or even network failure.

Figure 16 Troubleshooting Improper Network Cabling and Topology

PROBLEM	CORRECTIVE ACTION
Faulty cables	Using faulty network cables may affect data rates and have an impact on your network performance. Replace with new standard network cables.
Non-standard network cables	Non-standard cables may increase the number of network collisions and cause other network problems that affect your network performance. Refer to Section 2.2.4 on page 12 for more information on network cable types.
Cabling Length	If you use longer cables than are needed, transmission quality may be affected. The network cables should not be longer than the limit of 100 meters.
Too many hubs between the computers in the network	Too many hubs (or repeaters) between the connected computers in the network may increase the number of network collision or other network problems. Remove unnecessary hubs from the network.
A loop in the data path	A data path loop forms when there is more than one path or route between two networked computers. This results in broadcast storms that will severely affect your network performance. Make sure there are no loops in your network topology.

Legal Information

Copyright

Copyright © 2012 by ZyXEL Communications Corporation.

The contents of this publication may not be reproduced in any part or as a whole, transcribed, stored in a retrieval system, translated into any language, or transmitted in any form or by any means, electronic, mechanical, magnetic, optical, chemical, photocopying, manual, or otherwise, without the prior written permission of ZyXEL Communications Corporation.

Published by ZyXEL Communications Corporation. All rights reserved.

Disclaimer

ZyXEL does not assume any liability arising out of the application or use of any products, or software described herein. Neither does it convey any license under its patent rights nor the patent rights of others. ZyXEL further reserves the right to make changes in any products described herein without notice. This publication is subject to change without notice.

Certifications

Federal Communications Commission (FCC) Interference Statement

This device complies with Part 15 of FCC rules. Operation is subject to the following two conditions:

- This device may not cause harmful interference.
- This device must accept any interference received, including interference that may cause undesired operations.

FCC Warning

This device has been tested and found to comply with the limits for a Class A digital switch, pursuant to Part 15 of the FCC Rules. These limits are designed to provide reasonable protection against harmful interference in a commercial environment. This device generates, uses, and can radiate radio frequency energy and, if not installed and used in accordance with the instruction manual, may cause harmful interference to radio communications. Operation of this device in a residential area is likely to cause harmful interference in which case the user will be required to correct the interference at his own expense.

CE Mark Warning:

This is a class A product. In a domestic environment this product may cause radio interference in which case the user may be required to take adequate measures.

Taiwanese BSMI (Bureau of Standards, Metrology and Inspection) A Warning:

警告使用者
這是甲類的資訊產品，在居住的環境使用時，
可能造成射頻干擾，在這種情況下，
使用者會被要求採取某些適當的對策。

Notices

Changes or modifications not expressly approved by the party responsible for compliance could void the user's authority to operate the equipment.

Cet appareil numérique de la classe A est conforme à la norme NMB-003 du Canada.

CLASS 1 LASER PRODUCT

APPAREIL À LASER DE CLASS 1

PRODUCT COMPLIES WITH 21 CFR 1040.10 AND 1040.11.

PRODUIT CONFORME SELON 21 CFR 1040.10 ET 1040.11.

Viewing Certifications

Go to <http://www.zyxel.com> to view this product's documentation and certifications.

ZyXEL Limited Warranty

ZyXEL warrants to the original end user (purchaser) that this product is free from any defects in material or workmanship for a specific period (the Warranty Period) from the date of purchase. The Warranty Period varies by region. Check with your vendor and/or the authorized ZyXEL local distributor for details about the Warranty Period of this product. During the warranty period, and upon proof of purchase, should the product have indications of failure due to faulty workmanship and/or materials, ZyXEL will, at its discretion, repair or replace the defective products or components without charge for either parts or labor, and to whatever extent it shall deem necessary to restore the product or components to proper operating condition. Any replacement will consist of a new or re-manufactured functionally equivalent product of equal or higher value, and will be solely at the discretion of ZyXEL. This warranty shall not apply if the product has been modified, misused, tampered with, damaged by an act of God, or subjected to abnormal working conditions.

Note

Repair or replacement, as provided under this warranty, is the exclusive remedy of the purchaser. This warranty is in lieu of all other warranties, express or implied, including any implied warranty of merchantability or fitness for a particular use or purpose. ZyXEL shall in no event be held liable for indirect or consequential damages of any kind to the purchaser.

To obtain the services of this warranty, contact your vendor. You may also refer to the warranty policy for the region in which you bought the device at http://www.zyxel.com/web/support_warranty_info.php.

Registration

Register your product online to receive e-mail notices of firmware upgrades and information at www.zyxel.com for global products, or at www.us.zyxel.com for North American products.

Safety Warnings

- Do NOT use this product near water, for example, in a wet basement or near a swimming pool.
- Do NOT expose your device to dampness, dust or corrosive liquids.
- Do NOT store things on the device.
- Do NOT install, use, or service this device during a thunderstorm. There is a remote risk of electric shock from lightning.
- Do not obstruct the device ventilation slots as insufficient airflow may harm your device.
- Connect ONLY suitable accessories to the device.
- Do NOT open the device or unit. Opening or removing covers can expose you to dangerous high voltage points or other risks. ONLY qualified service personnel should service or disassemble this device. Please contact your vendor for further information.
- Make sure to connect the cables to the correct ports.
- Place connecting cables carefully so that no one will step on them or stumble over them.
- Always disconnect all cables from this device before servicing or disassembling.
- Use ONLY an appropriate power adaptor or cord for your device. Connect it to the right supply voltage (for example, 110V AC in North America or 230V AC in Europe).
- Use ONLY power wires of the appropriate wire gauge for your device. Connect it to a power supply of the correct voltage.
- Do NOT allow anything to rest on the power adaptor or cord and do NOT place the product where anyone can walk on the power adaptor or cord.
- Do NOT use the device if the power adaptor or cord is damaged as it might cause electrocution.
- If the power adaptor or cord is damaged, remove it from the device and the power source.
- Do NOT attempt to repair the power adaptor or cord. Contact your local vendor to order a new one.
- Fuse Warning! Replace a fuse only with a fuse of the same type and rating.

Your product is marked with this symbol, which is known as the WEEE mark. WEEE stands for Waste Electronics and Electrical Equipment. It means that used electrical and electronic products should not be mixed with general waste. Used electrical and electronic equipment should be treated separately.



Index

Numbers

10/100/1000 Mbps [5](#)

A

Applications [6](#)
 Segment Bridge [7](#)
auto-negotiating ports [10](#)

C

Cabling Length [18](#)
certifications
 notices [19](#)
 viewing [19](#)
copyright [19](#)

D

Data path loop [18](#)
disclaimer [19](#)

E

EEE [5, 10](#)
Energy Efficient Ethernet [10](#)

F

Faulty cables [18](#)
FCC interference statement [19](#)
Front Panel [9](#)

Front Panel Connections [12](#)

H

High Power over Ethernet [7](#)

I

IEEE 802.3at [7](#)
IEEE 802.3az [10](#)
installation
 precautions [15](#)
 transceivers [10](#)

L

LED Descriptions
 LK/ACT [13](#)
 PWR [13](#)
Low Power Idle [10](#)
LPI signal [10](#)

M

mounting brackets [15](#)

N

network cable
 crossover [12](#)
 straight-through [12](#)
Network Cable Types [12](#)
Non-standard network cables [18](#)

P

- PD [7](#)
- PoE [7](#)
 - power supplying [7](#)
- Power over Ethernet [7](#)
- power saving [10](#)
- powered device [7](#)
- product registration [20](#)

R

- rack mounting [14](#)
- Rear Panel [9](#)
- Rear Panel Power Connection [9](#)
- registration
 - product [20](#)

S

- safety warnings [20](#)
- Small Form-factor Pluggable (SFP) [10](#)
- Standalone Workgroup [6](#)

T

- transceiver MultiSource Agreement (MSA) [10](#)
- transceivers [10](#)
 - installation [10](#)
 - removal [11](#)
- Troubleshooting
 - Improper Network Cabling and Topology [18](#)

W

- wall mounting [14](#)
- warranty [19](#)
 - note [20](#)