



PLA4231

500 Mbps Powerline Wireless N Extender

Version 1.00
Edition 1, 12/2012

User's Guide

Default Login Details

LAN IP Address	http://192.168.1.2
Password	1234

IMPORTANT!

READ CAREFULLY BEFORE USE.

KEEP THIS GUIDE FOR FUTURE REFERENCE.

Screenshots and graphics in this book may differ slightly from your product due to differences in your product firmware or your computer operating system. Every effort has been made to ensure that the information in this manual is accurate.

Related Documentation

- Quick Start Guide

The Quick Start Guide shows how to connect the PLA4231 and access the Web Configurator.

Table of Contents

Table of Contents	3
Part I: Introduction	7
Chapter 1	
Introducing the PLA4231	9
1.1 Overview	9
1.2 Expand Your Network with the PLA4231	9
1.3 Ways to Manage the PLA4231	10
1.4 Good Habits for Managing the PLA4231	10
1.5 Powerline Security	10
1.5.1 Powerline Passwords	11
1.5.2 Setting Up Powerline Security	11
1.6 Multiple Networks	12
1.7 Resetting the PLA4231	12
1.7.1 Procedure to Use the Reset Button	12
Chapter 2	
The WPS Button.....	13
2.1 WPS Overview	13
2.2 How to Use the WPS Button	13
Chapter 3	
The RESET/ENCRYPT Button.....	15
3.1 RESET/ENCRYPT Button Overview	15
3.2 Set Up a HomePlug AV Network with ENCRYPT	15
3.3 Setting Up Multiple Networks	17
3.4 RESET/ENCRYPT Button Behavior	19
Part II: Configuration Utility	21
Chapter 4	
Installing the Powerline Configuration Utility	23
4.1 Overview of the Installation Process	23
4.2 Installing the Utility	23

Chapter 5	
Using the Powerline Configuration Utility	27
5.1 Overview	27
5.1.1 Powerline Network Security	27
5.1.2 Device Access Key (DAK)	28
5.2 Starting the Configuration Utility	28
5.3 Configuration Screen	29
5.4 Firmware Screen	30
5.5 Network Info Screen	31
5.6 Advanced Screen	32
5.7 About Screen	35
Chapter 6	
Powerline Network Setup Tutorial.....	37
6.1 Overview	37
6.2 Important Terms	37
6.3 Accessing Your Powerline Adapter	38
6.4 Adding a Powerline Adapter	39
6.5 Setting Up a New Network with a New Adapter	40
6.6 Splitting a Network into Two Networks	42
6.7 Troubleshooting	44
Part III: Web Configurator	47
Chapter 7	
Introducing the Web Configurator	49
7.1 Overview	49
7.2 Accessing the Web Configurator	49
7.2.1 Login Screen	49
7.2.2 Password Screen	51
7.3 Navigating the Web Configurator	52
7.3.1 Title Bar	53
7.3.2 Navigation Panel	53
7.3.3 Main Window	54
Chapter 8	
Dashboard	55
8.1 The Dashboard Screen	55
Chapter 9	
Monitor.....	59

9.1 Overview	59
9.2 What You Can Do	59
9.3 Log	59
9.4 Packet Statistics	60
9.5 WLAN Station Status	61
Chapter 10	
Wireless LAN.....	63
10.1 Overview	63
10.2 What You Can Do	63
10.3 What You Should Know	64
10.3.1 Wireless Security Overview	64
10.4 General Wireless LAN Screen	66
10.5 Wireless Security	67
10.5.1 No Security	67
10.5.2 WEP Encryption	68
10.5.3 WPA-PSK/WPA2-PSK	70
10.6 MAC Filter	71
10.7 Wireless LAN Advanced Screen	73
10.8 Quality of Service (QoS) Screen	73
10.9 WPS Screen	74
10.10 WPS Station Screen	76
10.11 Scheduling Screen	76
Chapter 11	
LAN	79
11.1 Overview	79
11.2 What You Can Do	79
11.3 What You Need To Know	79
11.3.1 LAN TCP/IP	80
11.3.2 IP Alias	80
11.4 LAN IP Screen	80
11.5 IP Alias Screen	81
Chapter 12	
HomePlug	83
12.1 Overview	83
12.2 What You Can Do	83
12.3 HomePlug Screen	83
Chapter 13	
Maintenance	87
13.1 Overview	87

13.2 What You Can Do	87
13.3 General Screen	87
13.4 Password Screen	88
13.5 Time Setting Screen	88
13.6 Firmware Upgrade Screen	90
13.7 Configuration Backup/Restore Screen	92
13.8 Restart Screen	93
13.9 Language Screen	93
Chapter 14	
LEDs and Troubleshooting	95
14.1 LEDs	95
14.2 Power and Light Problems	96
14.3 Configuration Utility Problems	98
14.4 Powerline Problems	98
14.5 RESET/ENCRYPT Button Problems	99
14.6 Wireless Connection Problems	100
14.7 PLA4231 Access and Login Problems	101
Appendix A Pop-up Windows, JavaScript and Java Permissions	105
Appendix B Legal Information.....	115
Index	121

PART I

Introduction

Introducing the PLA4231

1.1 Overview

This chapter introduces the main applications and features of the PLA4231 HomePlug AV compliant powerline adapter.

In this User's Guide the electrical wiring network is referred to as the "powerline network". The HomePlug AV standard specifies how network devices communicate using standard electrical wiring.

1.2 Expand Your Network with the PLA4231

The PLA4231 plugs into an ordinary power outlet to easily extend a cable or DSL broadband connection or existing Ethernet (LAN) network to any other electrical outlet in any room of a house, all without the need for any new cabling. Devices can securely communicate with each other at high data transfer rates. The PLA4231 uses 128-bit Advanced Encryption Standard (AES) to ensure safe transfer of information.

Figure 1 Expand Your Network with the PLA4231

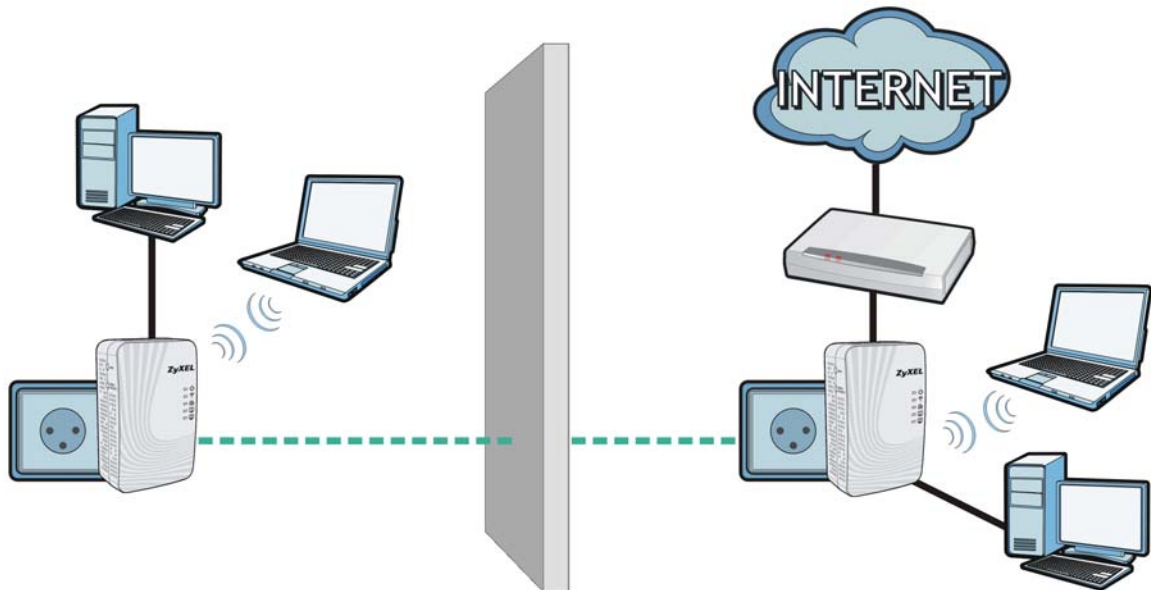

Connect your PLA4231 to an Internet gateway such as a modem and plug it into an ordinary power outlet in your home. Plug a second PLA4231 into another power outlet and connect a computer to the PLA4231 for Internet access. You can also connect a computer to your existing wireless network through the PLA4231 which acts as an AP or wireless extender. Your network can be further

expanded by plugging additional PLA4231s into other outlets in your home and connecting other computers or network devices (for example, a printer) to them.

Refer to your Quick Start Guide for hardware connection information.

1.3 Ways to Manage the PLA4231

- Use the **RESET/ENCRYPT** button to add powerline devices to your powerline network if they have this button. See [Chapter 3 on page 15](#) for instructions on using the ENCRYPT feature.
- Use the **PLA42xx Series Configuration Utility** (or utility, for short) to manage the PLA4231. See [Chapter 4 on page 23](#) for instructions on installing the utility.

Note: This User's Guide describes the latest version utility. This utility is only compatible with a PLA4231 which has the latest firmware installed. If you don't already have them, download the latest firmware and utility from the ZyXEL website.

- Use the Web Configurator for everyday management of the PLA4231 using a (supported) web browser. See [Section 7.2 on page 49](#) for instructions on accessing the Web Configurator.
- WPS (Wi-Fi Protected Setup) button. You can use the WPS button or the WPS section of the Web Configurator to set up a wireless network with your PLA4231. See [Section on page 13](#) for instructions on using the WPS button.

1.4 Good Habits for Managing the PLA4231

Do the following things regularly to make the PLA4231 more secure and to manage the PLA4231 more effectively.

- Change the password. Use a password that's not easy to guess and that consists of different types of characters, such as numbers and letters.
- Write down the password and put it in a safe place.
- Back up the configuration (and make sure you know how to restore it). Restoring an earlier working configuration may be useful if the device becomes unstable or even crashes. If you forget your password, you will have to reset the PLA4231 to its factory default settings. If you backed up an earlier configuration file, you would not have to totally re-configure the PLA4231. You could simply restore your last configuration.

1.5 Powerline Security

Since your powerline network may extend outside your premises, it is important to set up security on your PLA4231.

1.5.1 Powerline Passwords

You use two types of passwords in the HomePlug AV powerline network. The following table describes the differences between the passwords.

Table 1 Powerline Password Summary

PASSWORD	DESCRIPTION
Network Name	All powerline adapters that follow the HomePlug AV standard are shipped with the same powerline network name "HomePlugAV". Change the network name via the PLA42xx Series Configuration Utility to create a private network. See Section 5.3 on page 29 .
DAK (Data Access Key) Password	In order to manage the powerline adapters on your powerline network you must enter the adapters' DAK password in the PLA42xx Series Configuration Utility . This password is printed on the powerline adapter itself. You don't need to add the password for the powerline adapter directly connected to the computer running the configuration utility (local powerline adapter), you only have to add the remote powerline adapters' passwords (those on your circuit, but not directly connected to your computer).

1.5.2 Setting Up Powerline Security

The ENCRYPT feature automatically sets up security on your powerline network. Use this feature if your powerline devices have the **RESET/ENCRYPT** button.

If your devices do not have the **RESET/ENCRYPT** button, use the **PLA42xx Series Configuration Utility** to set up security on the PLA4231. Although the PLA4231 is a "plug-and-play" network expanding solution there are several reasons for enabling security on the powerline network in your home.

- 1 It's easy and only requires you to change a network name.
- 2 It's a good idea to ensure privacy of your communication. When you use the PLA4231 and other powerline adapters, the electrical wiring in your home becomes an extension of your Ethernet network. Your network traffic flows freely within the electrical circuit of your home and is bounded in most cases by a power meter.

Without security (encryption) your information is accessible to anyone using a powerline adapter on the same electrical circuit. In some cases, a circuit can be shared by more than one household.

To prevent compromising your network security, you can create a private network. A private network uses a secret password (**Network Name**) to make sure that only permitted powerline adapters can communicate in your network. See [Section 5.3 on page 29](#) for information on setting up a private network.

- 3 You may need to change the **Network Name** to create multiple powerline networks. See the next section for more information on how to set up a multiple network.

1.6 Multiple Networks

Multiple powerline networks can coexist on a single powerline circuit. You might want to implement multiple powerline networks in a small office environment where you have two separate Ethernet networks.

- 1 Connect one powerline adapter to a router or switch on the first Ethernet network and assign a **Network Name** (for example "Password1") to this powerline adapter. Add additional powerline adapters to your network by plugging them into your powerline outlets and assigning them "Password1". This completes the configuration of your first powerline network.
- 2 Connect another powerline adapter to a router or switch on the second Ethernet network and assign a different **Network Name** (for example "Password2") to this powerline adapter. Again, add additional powerline adapters and assign them "Password2".

You now have two private networks on your powerline circuit. Information is not shared between the two networks as only powerline adapters with the same **Network Name** can communicate with each other.

1.7 Resetting the PLA4231

If you forget your password or IP address, or you cannot access the Web Configurator, you will need to use the **RESET/ENCRYPT** button at the side of the PLA4231 to reload the factory-default configuration file. This means that you will lose all configurations that you had previously saved, the password will be reset to "1234" and the IP address will be reset to "192.168.1.2".

1.7.1 Procedure to Use the Reset Button

- 1 Make sure the power LED is on.
- 2 Press the **RESET** button for 10 to 15 seconds (until the power LED begins to blink) and release it to set the PLA4231 back to its factory-default configurations.

The WPS Button

2.1 WPS Overview

Your PLA4231 supports Wi-Fi Protected Setup (WPS), which is an easy way to set up a secure wireless network. WPS is an industry standard specification, defined by the Wi-Fi Alliance.

WPS allows you to quickly set up a wireless network with strong security, without having to configure security settings manually. Each WPS connection works between two devices. Both devices must support WPS (check each device's documentation to make sure).

Depending on the devices you have, you can either press a button (on the device itself, or in its configuration utility) or enter a PIN (a unique Personal Identification Number that allows one device to authenticate the other) in each of the two devices. When WPS is activated on a device, it has two minutes to find another device that also has WPS activated. Then, the two devices connect and set up a secure network by themselves.

2.2 How to Use the WPS Button

You can use the WPS button on the side panel of the PLA4231 to activate WPS.

- 1 Make sure the power LED and the WLAN LED are on (not blinking).
- 2 To copy wireless settings (SSID and wireless security key for example) from an access point (AP) or wireless router, press the WPS button for longer than five seconds and release it. The WLAN LED begins to blink.

To connect a WPS-enabled wireless client (such as your computer with a WPS-enabled wireless adapter) to the PLA4231 via Wi-Fi or to the existing wireless network through the PLA4231, press the WPS button for two or three seconds and release it. The WLAN LED begins to blink.

- 3 Press the WPS button on another WPS-enabled device within range of the PLA4231.
- 4 The WLAN LED turns steady on when WPS was successful. The WLAN LED will be off for about ten seconds if WPS has failed, and comes on again.

Note: You must activate WPS in the PLA4231 and in another wireless device within two minutes of each other.

The RESET/ENCRYPT Button

Use the **RESET/ENCRYPT** button to automatically set up a secure powerline connection between your powerline devices.

3.1 RESET/ENCRYPT Button Overview

The **RESET/ENCRYPT** button allows you to set up a secure powerline connection with other HomePlug AV compliant powerline devices which also support the ENCRYPT feature. No other powerline setting changes are required to connect.

You can use the **RESET/ENCRYPT** button to:

- set up a new powerline network.
- separate an existing powerline network into multiple networks.
- reset the PLA4231 to the factory defaults.

3.2 Set Up a HomePlug AV Network with ENCRYPT

You can connect a number of devices on a powerline network, but you can use the **RESET/ENCRYPT** button on only two devices at a time.

Place a powerline device close to another powerline device so you have time to set up each one. After you set up the first powerline device, you have 120 seconds to set up the second powerline device.

You can disconnect them from your computer or modem (or other networking equipment) if you need to move them close to each other, but the powerline devices need to be plugged into power outlets.

Follow the steps below to set up your HomePlug AV Network:

- 1 Press and hold the **RESET/ENCRYPT** button at the side of your powerline device for 5 to 8 seconds and then release it. This resets the network name to a random value and removes your device from any network it may belong to.

- 2 Press the **RESET/ENCRYPT** button at the side of your powerline device for 0.5 to 3 seconds. The power (⏻) light will blink as the powerline device tries to set up a connection.

Figure 2 ENCRYPT Connection Procedure

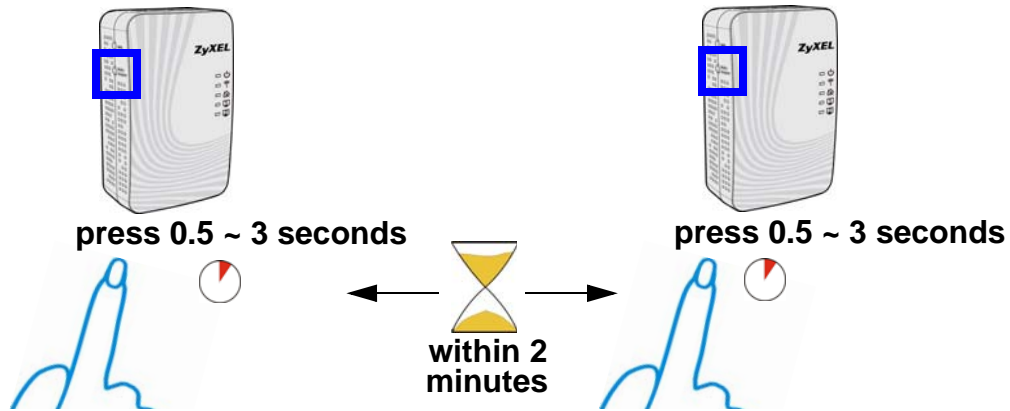

Note: The **RESET/ENCRYPT** button's location varies for each Powerline model.

- 3 Repeat step 2 in this section for the other powerline device you wish to connect. This must be done within 120 seconds of pressing the **RESET/ENCRYPT** button on the PLA4231.

Note: Check the lights on the two powerline devices. The power (⏻) and HomePlug (🏠) lights should be blinking while the devices are connecting. Several times all lights blink simultaneously and the HomePlug (🏠) light also shows red. Wait for about one minute while your powerline devices connect.

If the power (⏻) light does not blink when you press **RESET/ENCRYPT**, you have probably pressed the **RESET/ENCRYPT** button for too long. Try again, pressing the **RESET/ENCRYPT** button for 0.5 to 3 seconds.

If the HomePlug (🏠) lights on both powerline devices do not light up, the powerline devices are not connected. Repeat steps 2 and 3 in this section. If that doesn't work, see the Troubleshooting in Section 14.5 on page 99 for suggestions.

- 4 To add more powerline devices to your network, press and hold the **RESET/ENCRYPT** button on device C (shown below) for for 5 to 8 seconds and then release it.

- Then repeat steps 2 and 3 in this section using any powerline device (**A** or **B**) you have connected using ENCRYPT and the powerline device you want to connect (**C**). You must use the **RESET/ENCRYPT** button on both devices.

Figure 3 Adding More Powerline Adapters to Your Network

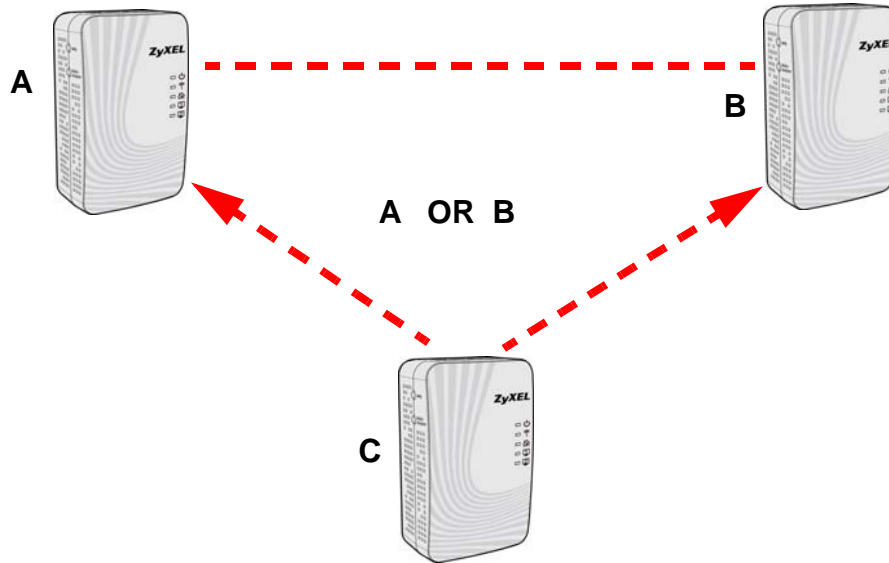

- If you disconnected your computer or modem (or any other networking product connected to your powerline device) in step of this section, you can now reconnect them.

This sets up your powerline network between your powerline devices.

3.3 Setting Up Multiple Networks

You can use the **RESET/ENCRYPT** button to set up multiple powerline networks using your existing powerline network.

For example, you have already set up a powerline network in your home (A) which accesses a printer (B). Now you want a separate powerline network connection from your laptop to your printer (C).

Figure 4 One Existing Powerline Network

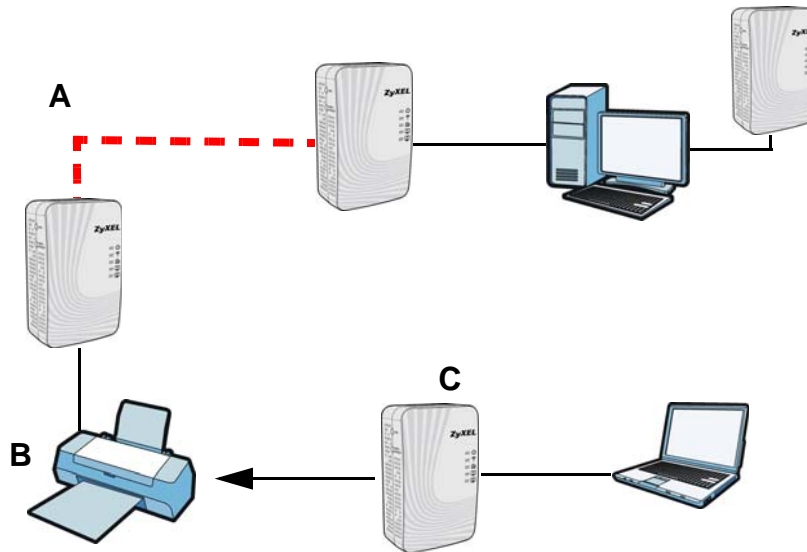

- 1 Click the **RESET/ENCRYPT** button on (A) for 5 to 8 seconds and then release it. This disconnects (A) from (B).
- 2 Click the **RESET/ENCRYPT** button on (A) and (C) for 0.5 to 3 seconds and within two minutes of each other.
- 3 Wait for about one minute while (A) and (C) connect.
- 4 Check the LEDs on both (A) and (C). When the power (⏻) and HomePlug (🏠) lights stop blinking and the power (⏻) light shines steadily, the devices are connected.

Figure 5 Two Separate Powerline Networks

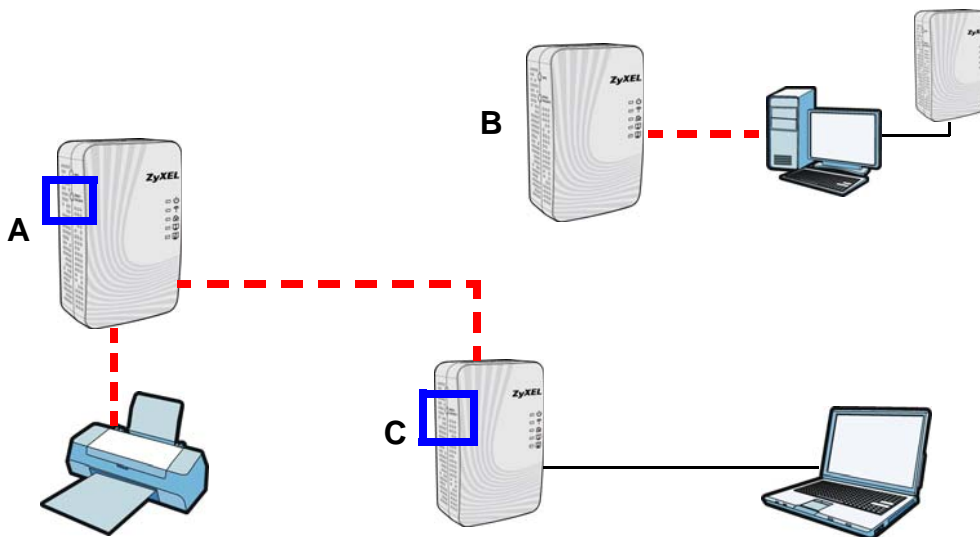

Congratulations. You now have two separate powerline networks as shown above.

If the HomePlug (🏠) lights on both powerline devices do not light up, the powerline devices are not connected. Repeat the connection process, making certain you press the **RESET/ENCRYPT** buttons for the correct time and within two minutes of each other. If that does not work see Section 14.5 on page 99 for suggestions.

3.4 RESET/ENCRYPT Button Behavior

The following table summarizes the actions that occur when the **RESET/ENCRYPT** button is pressed for specific lengths of time.

Table 2 Time **RESET/ENCRYPT** Button is Pressed and Action

TIME	ACTION	POWER LIGHT BEHAVIOR	HOMEPLUG LIGHT BEHAVIOR
0.5 to 3 seconds	The device joins a network. It shares the same network name as other devices on the network.	The power (🔌) light blinks until the device is connected. This may take a minute.	The HomePlug (🏠) light turns on if your device is connected to another powerline device or a powerline network.
5 to 8 seconds	The device leaves any network it is associated with and its network name assumes a random value.	The power (🔌) light blinks several times and then shines steadily.	The HomePlug (🏠) light blinks red one time and then turns off when it disconnects from the powerline network.
10 to 15 seconds	Clear all user-entered configuration information and return the device to its factory defaults.	The power (🔌) light blinks several times and then shines steadily.	The HomePlug (🏠) light blinks red one time and then turns off when it disconnects from the powerline network.

See Troubleshooting in [Chapter 14 on page 99](#) for suggestions on problems with the **RESET/ENCRYPT** button and the lights.

PART II

Configuration Utility

Installing the Powerline Configuration Utility

This chapter guides you through the installation of the configuration utility for your PLA4231.

4.1 Overview of the Installation Process

The installation of the configuration utility does the following:

- 1 Checks for and installs Microsoft's .NET Framework version 2.0 software on your computer. This software is necessary for the installation of the **PLA42xx Series Configuration Utility**. If you already have .NET Framework version 2.0 installed on your computer this step will be skipped.

Note: At the time of writing the **Utility** is only compatible with Microsoft Windows XP, Microsoft Windows Vista (32-bit version), Microsoft Windows 7 and Microsoft Windows 8 operating systems. Users with Windows XP (64-Bit version) operating systems can go to Microsoft's website to upgrade their systems to .NET Framework version 2.0 so it can work with the **utility**. To check for your Windows operating system version, right-click on **My Computer > Properties**. You should see this information in the **General** tab.

- 2 Installs ZyXEL's **PLA42xx Series Configuration Utility**. This utility allows you to manage the network name (See [Section 5.3 on page 29](#) for more information) or view the devices recognized on your powerline network.

Note: This User's Guide describes the latest version utility. This utility is only compatible with a PLA4231 which has the latest firmware installed. If you don't already have them, download the latest firmware and utility from the ZyXEL website.

4.2 Installing the Utility

Follow the steps below to install .NET Framework version 2.0 and the **PLA42xx Series Configuration Utility** on your computer.

- 1 Insert the included CD-ROM into your computer's CD-ROM drive. The Setup utility runs automatically. Alternatively this can also be done manually by double clicking the **setup.exe** file on the CD. A prompt appears asking you to install the .NET Framework version 2.0. Review Microsoft's **License Agreement**, select **Accept** to proceed.

Figure 6 .NET Framework Installation Prompt

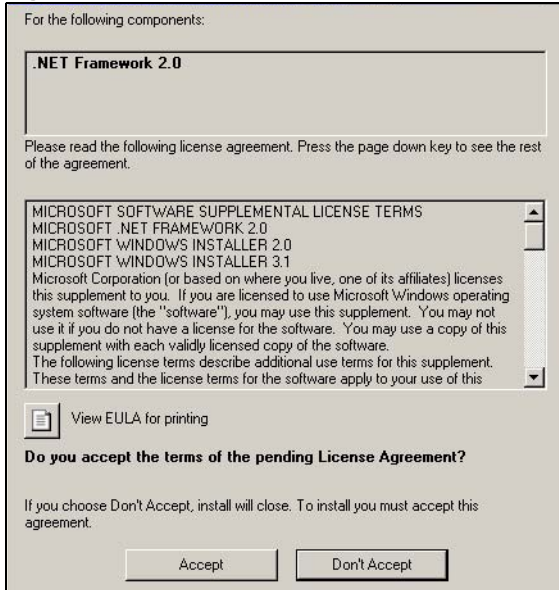

- 2 The next screen allows you to see the progress of the installation.

Figure 7 .NET Framework Installation Process

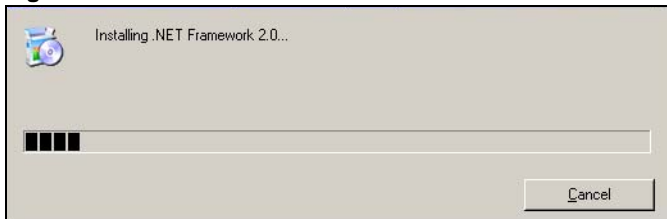

- 3 The Setup utility runs automatically. Click **Yes** or **Next** to continue through the initial screen. Click **Cancel** only if you want to abort the installation.

Figure 8 InstallShield Wizard Start Screen

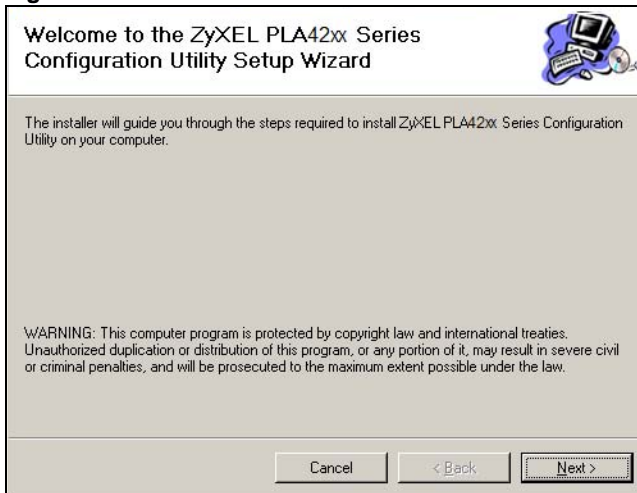

- 4 If you want the utility to be only available to the currently logged in user, select **Just me**. Otherwise, click **Everyone** to allow all users to use the configuration utility. Click **Next** to install the utility to the default folder, or click **Browse** to specify a different location on your computer.

Figure 9 Install Destination Folder

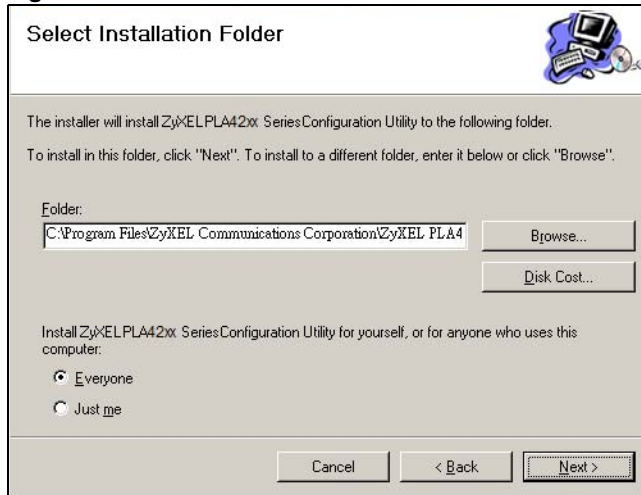

Note: You can also click **Disk Cost** to know how much available disk space you have in the hard drives found in your computer.

- 5 When the installation is finished, a screen appears to confirm the **InstallShield Wizard** has successfully installed the **PLA42xx Series Configuration Utility** to your computer. Click **Close** to exit the wizard.

Figure 10 Installation Complete

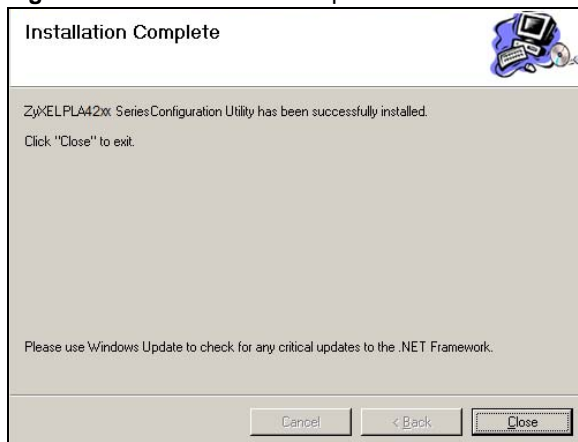

Note: You may be asked to restart your computer when the installation is complete. Click "Yes" to restart your computer. If you select "No, I will restart my computer later", you will not be able to launch the utility until after a restart of your computer.

Using the Powerline Configuration Utility

5.1 Overview

This chapter shows you how to use the Configuration Utility (or Utility) to secure, manage and set up Quality of Service (QoS) on your powerline network.

The PLA4231 is designed as a plug-and-play network expanding solution. This means that once you complete your hardware connections, the PLA4231s in your network (without additional configuration) are able to communicate with each other by sending and receiving information over your home's electrical wiring (**A**).

Figure 11 Example Network Setup

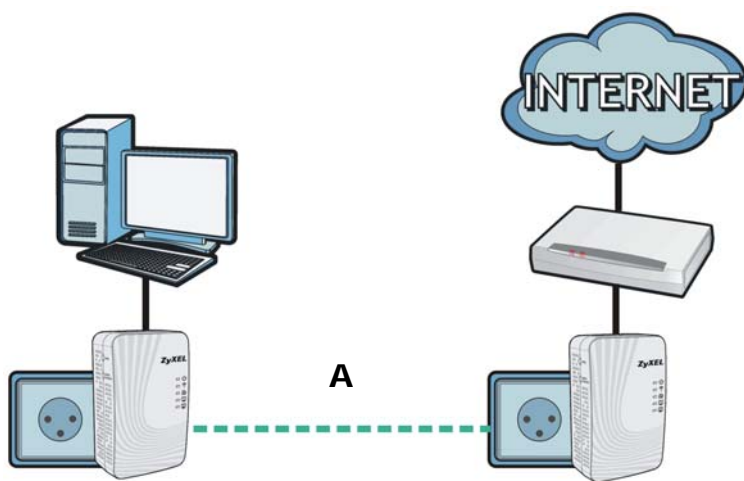

All HomePlug AV compliant powerline adapters within range can join your network. The range varies depending on the quality of your home's wiring.

Note: See [Section 5.1.1 on page 27](#) for more information on enhancing your powerline network security.

5.1.1 Powerline Network Security

When the PLA4231s communicate with each other, they use encryption to protect the information that is sent in the powerline network. Encryption is like a secret code. If you do not know the secret code, you cannot understand the message. The HomePlug AV standard uses 128-bit AES (Advanced Encryption Standard) to safely transmit data between powerline adapters.

For the powerline adapters to communicate with each other they all need to use the same network name. This network name allows the powerline adapters to understand the encrypted information sent in the powerline network.

By default the PLA4231s are all configured with the network name **HomePlugAV**, this allows you to simply plug the devices in and not worry about setting up security. If you want to enhance the security on your powerline network, you can change the network name on the powerline adapters you want to allow to communicate in your powerline network.

5.1.2 Device Access Key (DAK)

In order to manage the powerline adapters on your powerline network you must enter the adapters' password in the **PLA42xx Series Configuration Utility**. This password is called the DAK (Device Access Key) password. This password is printed on the powerline adapter itself.

You don't need to enter the DAK password for the powerline adapter directly connected to the computer running the utility (local powerline adapter), you only have to add the remote powerline adapters' passwords (those in your powerline network, but not directly connected to your computer).

5.2 Starting the Configuration Utility

To launch the **PLA42xx Series Configuration Utility** simply double click on the configuration icon on your desktop.

Figure 12 PLA42xx Series Configuration Utility Icon



Alternatively, start the utility by browsing to it from the start menu. Click **Start > Programs > ZyXEL PLA42xx Series Configuration > PLA42xx Series Configuration**.

5.3 Configuration Screen

Use the **Configuration** screen to see which devices are recognized by your powerline network, to configure your PLA4231 and to set up a secure powerline network by changing the powerline network name. This screen opens up when you launch the utility.

Figure 13 Configuration Screen

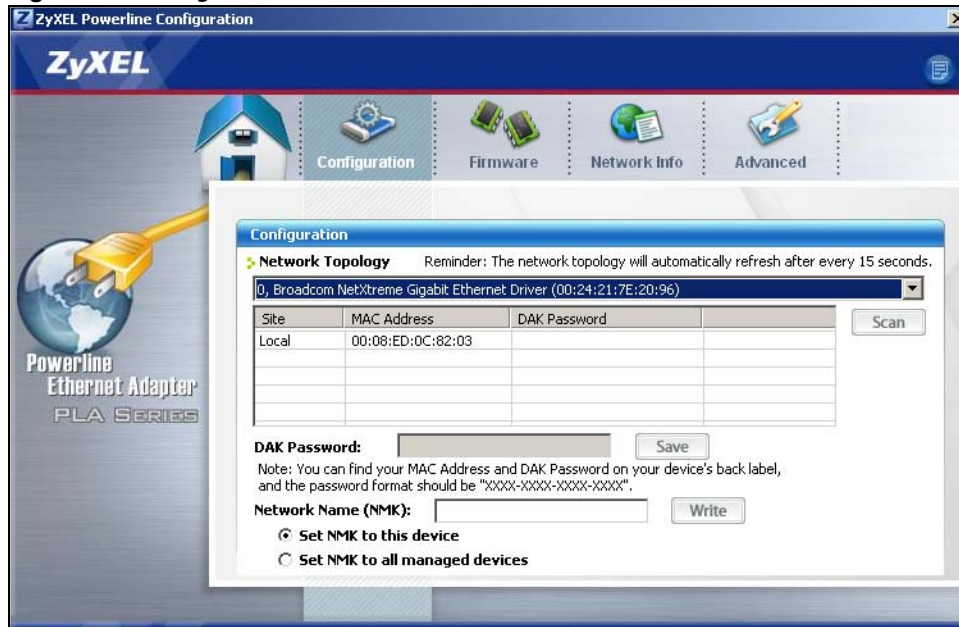

The following table describes the labels in this screen.

Table 3 Configuration Screen

LABEL	DESCRIPTION
Network Topology	Use this to select which powerline network information is displayed. Different powerline networks are identified by the Ethernet interface (network card) on your computer which is connected directly to a powerline adapter. Typically there is only one connection. However, if your computer has two network cards and both are connected to a powerline adapter, then you have two powerline networks.
The fields described below are used to identify the powerline adapters recognized on the powerline network. The configuration utility automatically updates this information every 10 seconds. Click Scan to refresh the information in these fields (immediately).	
Note: Only devices which share the same network name are displayed in this table.	
Site	This field displays <ul style="list-style-type: none"> Local, if it is identifying the powerline adapter directly connected to the computer running the configuration utility. Remote, if it is a powerline adapter in your powerline network but not directly connected to the computer running the configuration utility.
MAC Address	This is a read-only field which shows the MAC address of the powerline adapter you are configuring. You can find the MAC address of your PLA4231 displayed on a sticker on the bottom of your device.

Table 3 Configuration Screen (continued)

LABEL	DESCRIPTION
DAK Password	<p>DAK (Device Access Key) password is used to verify that you are authorized to perform changes on a remote device. You can find the DAK password printed on a sticker on the bottom of your PLA4231.</p> <p>Select the remote powerline adapter you want to manage by clicking the MAC address which corresponds to it in the MAC Address column. Enter the DAK Password value and click Save.</p> <p>Note: You must enter the DAK Password value exactly as it is printed on the label (all caps and with dashes "-").</p>
Network Name (NMK)	<p>The default network name (sometimes called a network password or network membership key (NMK)) of the PLA4231 is "HomePlugAV". HomePlug compatible devices use the same network name to recognize and communicate with each other over the powerline network. If you change the network name of one device on the network, it will no longer be recognized as part of that network.</p> <p>If you change the network name, make sure you change the network name for all of the powerline adapters that you want to be part of your powerline network.</p> <p>The network name can be from 8 to 64 characters in length, using "A"~"Z", "a"~"z", "0"~"9"; spaces are not allowed.</p>
Set NMK to this device	<p>Select this to apply the NMK (entered in the field above) as the network name for the powerline adapter directly connected to the computer running the configuration utility.</p>
Set NMK to all devices	<p>Select this to apply the NMK (entered in the field above) as the network name for all powerline adapter detected by the utility.</p>
Save	<p>Click this to apply your changes. The new Network Name is applied to the selected powerline adapter.</p> <p>Note: You must enter the correct DAK password for the selected powerline adapter before you can make changes to it.</p>

5.4 Firmware Screen

Use the **Firmware** screen to update the firmware on the PLA4231 directly connected to the computer running the configuration utility.

Firmware is the software which is embedded in the PLA4231. This software contains processing instructions for how the PLA4231 sends and receives information in a secure way.

Parameter Information Block (PIB) is similar to firmware. It contains the most basic operating instructions for the PLA4231 such as how to power up and how to load the firmware.

You can check the ZyXEL website for firmware upgrades for your PLA4231.

Note: If you have upgraded the firmware, make sure you also upgrade the **PLA42xx Series Configuration Utility**. Older version utilities are not compatible with PLA4231s using the latest firmware.

Note: Be sure to upload the correct model firmware as uploading the wrong model firmware may damage your device.

Figure 14 Firmware Screen

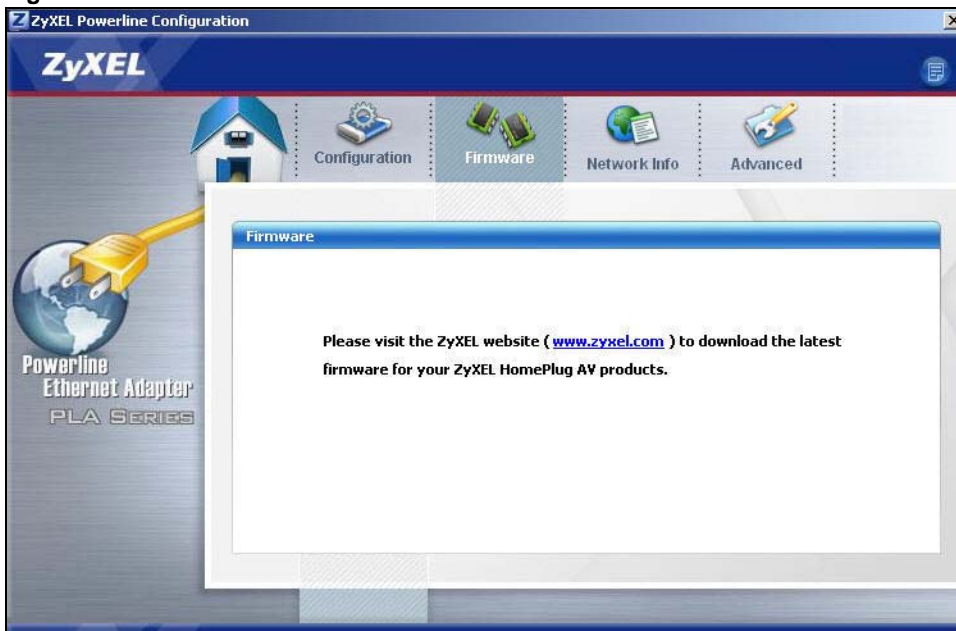

5.5 Network Info Screen

Use the **Network Info** screen to see the rates at which a specific PLA4231 is communicating with other powerline adapters on your powerline network.

Figure 15 Network Info Screen

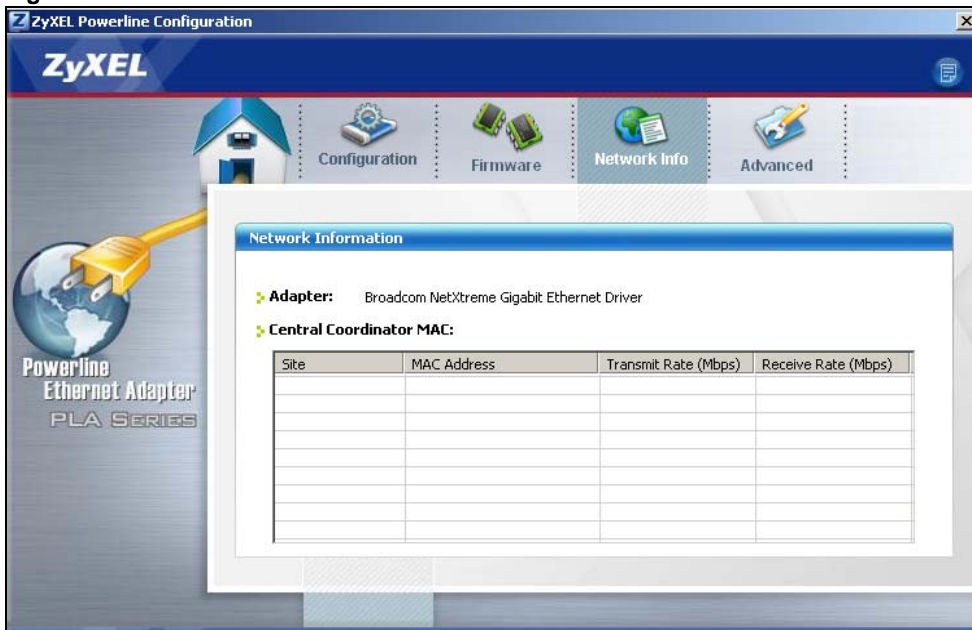

The following table describes the labels in this screen.

Table 4 Network Info Screen

LABEL	DESCRIPTION
Adapter	This field identifies which powerline network information is displayed. Different powerline networks are identified by the Ethernet interface (network card) on your computer which is connected directly to a powerline adapter. Typically there is only one connection. However, if your computer has two network cards and both are connected to a powerline adapter, then you have two powerline networks.
Central Coordinator MAC	The Central Coordinator of the powerline network is the powerline adapter which keeps track of which devices are part of the network as well as synchronizes communication within the powerline network. If the Central Coordinator is removed from the powerline network then another powerline adapter takes its place. This field displays the MAC address of the PLA4231 which is the Central Coordinator of the powerline network. The powerline adapters in your powerline network automatically select the Central Coordinator.
<p>The information provided in the following table reflects transmission rate information about the powerline adapters which communicate in your powerline network.</p> <p>The powerline adapters listed in this table are all the powerline adapters in your powerline network except the powerline adapter selected in the Configuration page of the configuration utility. In other words, if the Local powerline adapter is selected in the Configuration screen, then this table will display the rates of transmission from the powerline adapter connected to the computer running the configuration utility to all the Remote powerline adapters.</p>	
Site	<p>This field displays:</p> <ul style="list-style-type: none"> • Local, if it is the PLA4231 directly connected to the computer running the configuration utility. • Remote, if it is a PLA4231 in your powerline network but not directly connected to the computer running the configuration utility.
MAC Address	This field displays the MAC address of your powerline adapter. The MAC address of your powerline adapter can be found by looking at the label on your device. It consists of six pairs of hexadecimal characters (hexadecimal characters are "0-9" and "a-f"). In the case of the PLA4231, this label is on the bottom of the device.
Transmit Rate (Mbps)	This field displays how fast information is sent from the powerline adapter selected in the Configuration screen to this powerline adapter. The rate is given in the following format: "application data transmission rate / raw data transmission rate". Application data reflects more accurately how fast devices are transmitting application relevant traffic (for example Internet Protocol (IP) traffic). Raw data refers to the whole payload of the packets transmitted across the powerline network.
Receive Rate (Mbps)	This field displays how fast information is received from the powerline adapter selected in the Configuration screen to this powerline adapter. The rate is given in the following format: "application data transmission rate / raw data transmission rate". Application data reflects more accurately how fast devices are transmitting application relevant traffic (for example Internet Protocol (IP) traffic). Raw data refers to the whole payload of the packets transmitted across the powerline network.

5.6 Advanced Screen

Note: This feature is only available with the latest version utility. Go to the ZyXEL website to download the latest utility and firmware for your ZyXEL HomePlug AV adapter.

You can configure the powerline adapters on your network to give priority to network traffic depending on its importance. When you set the priority of a powerline adapter, you set how quickly messages FROM your powerline adapter are sent in your powerline network. Transmissions TO your powerline adapter do not receive any priority.

For example, if you have a file server on your home network to deliver music and movie files to computers in your home, you should set the priority of the powerline adapter connected to this server to **Medium**. If video traffic is delivered too slowly, quality problems may occur.

On the other hand, a powerline adapter attached to a printer should have a low priority setting since the slow delivery of messages will not affect the print job.

Similarly, if you want to prioritize any downloads from the Internet, set the priority on the powerline adapter attached to your Internet gateway to **High**.

Allocate priority settings based on application type as follows.

Table 5 Priority Settings

PRIORITY LEVEL	APPLICATION
High	Voice Application
Medium	Video and Audio Applications
Normal	Data Applications
Low	Data Applications

The figure below shows an example powerline home network connected to the Internet.

- Device A is a printer and does not handle traffic with high importance, so the powerline adapter connected to it can be set to low priority.
- Device B is a file server, delivering audio or movie files to other users on the network. The powerline adapter attached to it should have a medium setting.
- Device C, a home computer which connects to the Internet, can receive a normal priority setting as it usually sends simple requests for data. For example, when you surf the Internet, your computer sends requests to open web pages.
- Device D is a modem attached to the Internet. It should receive a high priority setting if you want faster downloading through your network.
- Although device E receives audio or movie files, it does not send a lot of traffic, so the powerline adaptor attached to it can be set to a low priority.

Figure 16 Priority Settings

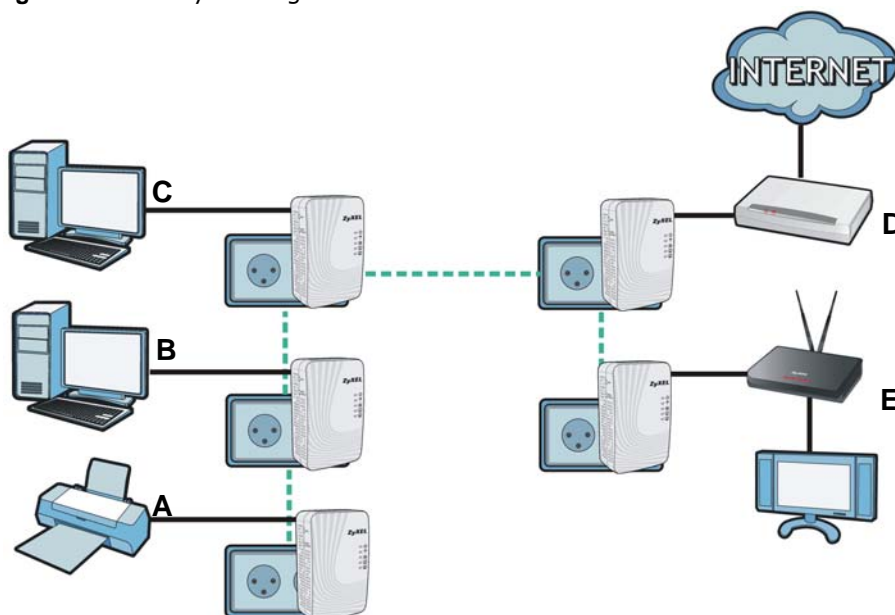

Use this screen to configure priority settings for traffic from the powerline adapters on your network.

Figure 17 Advanced Screen

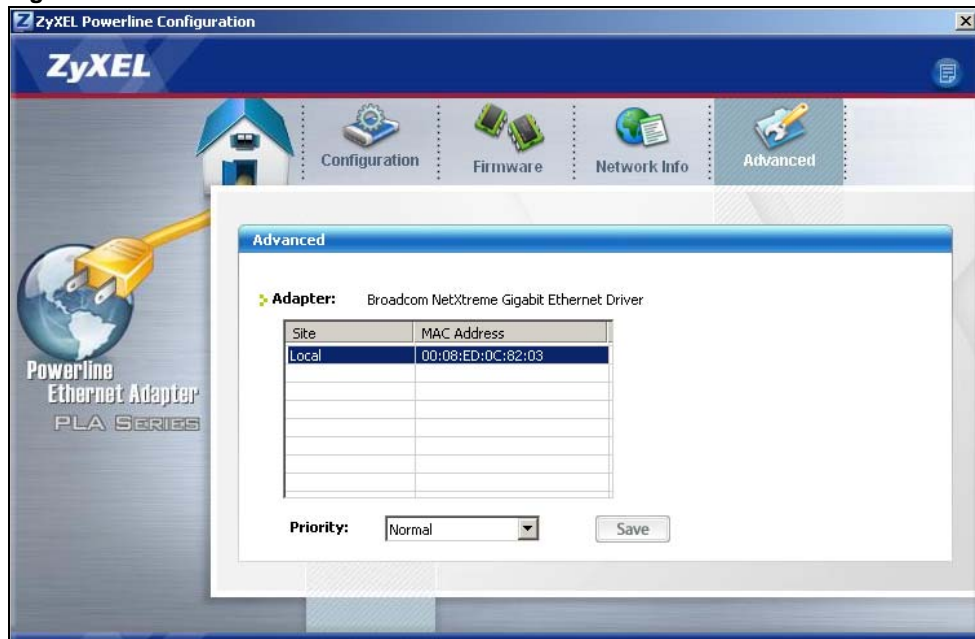

The following table describes the labels in this screen.

Table 6 Advanced Screen

LABEL	DESCRIPTION
Adapter	This field identifies which powerline network information is displayed. Different powerline networks are identified by the Ethernet interface (network card) on your computer which is connected directly to a powerline adapter. Typically there is only one connection. However, if your computer has two network cards and both are connected to a powerline adapter, then you have two powerline networks.
Site	This field displays: <ul style="list-style-type: none"> • Local, if it is the PLA4231 directly connected to the computer running the configuration utility. • Remote, if it is a powerline adapter in your powerline network but not directly connected to the computer running the configuration utility.
MAC Address	This is a read-only field which shows the MAC address of the powerline adapter you are configuring. You can find the MAC address of your PLA4231 displayed on a sticker on the bottom of your device.
Priority	Select a priority setting from the drop-down box for traffic FROM your selected device. The options, in order of importance, are High , Medium , Normal and Low .
Save	Click this to apply your changes. The new Priority setting is applied to the selected powerline adapter.

5.7 About Screen

Use the **About** screen to view information regarding the configuration utility and firmware version of the PLA4231 you are connected to. Click the  icon in the top right corner of the utility to view the **About** screen.

Figure 18 About Screen



The following table describes the labels in this screen.

Table 7 About Screen

LABEL	DESCRIPTION
Utility version:	This field displays the software version of the configuration utility.
Firmware version	This field displays the firmware version of the device you selected in the Device Selection field of the Configuration screen. In the example firmware version given in the screen, 1.0.0.337 , the firmware version is shown by the numbers 1.0.0 , meaning this is firmware version 1.0.0.
Released	This field displays the date when the firmware was released.
Close	Click the  button in upper right corner to close the About window.

Powerline Network Setup Tutorial

6.1 Overview

Use this tutorial to expand your existing powerline network.

After setting up your first home powerline network (instructions for that are in the Quick Start Guide for your ZyXEL powerline adapter) you may want to extend the network or create a new one by adding additional powerline adapters. This tutorial shows you the following.

- How to start up your new powerline adapter. You need to do this before you can begin the next sections.
- How to make your existing powerline network bigger by adding new powerline adapters.
- How to make a new network separate from your existing network with new powerline adapters.
- How to make a new, separate powerline network with the powerline adapters you have.

The tutorial uses the **PLA42xx Series Configuration Utility** to set up your powerline adapter.

If you haven't already installed the utility, see [Chapter 4 on page 23](#) for instructions. If you do not have the CD with the utility, the utility software is also available for download at www.zyxel.com. Navigate to the powerline products section of the ZyXEL website to find this software. Follow the instructions provided by the software to install it on your computer.

See the product specifications in the User's Guide for a list of hardware and software compatible with the utility.

Note: The PLA4231 in this tutorial is an example only. Your powerline adapter may be different.

6.2 Important Terms

Network Name	The network name allows a powerline adapter to connect with other powerline adapters that have the same network name. It provides security for your powerline network. The network name uses English letters or numbers, from 8 to 64 characters long, with no spaces allowed.
DAK Password	DAK = Device Access Key. The DAK Password lets you access the powerline adapter. You can find the DAK Password on a label on your powerline device.

6.3 Accessing Your Powerline Adapter

- 1 Plug the powerline adapter you want to add to your network into a power socket and, if needed, switch the power socket on.

Figure 19 Plug Your Powerline Adapter into a Power Socket

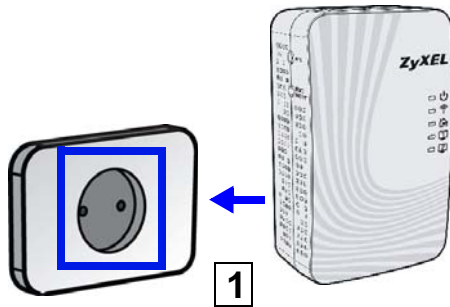

- 2 Connect the powerline adapter to your computer.
- 3 Use a LAN or Ethernet cable (shown below) to connect the LAN or Ethernet port on your adapter to the same kind of port on your computer.

Figure 20 Connect Your Powerline Adapter to a Computer

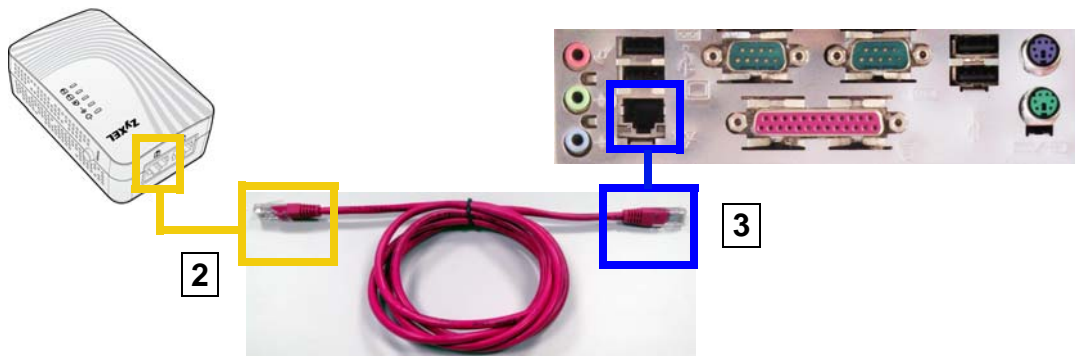

- 4 Open the **PLA42xx Series Configuration Utility** on your computer. Go to **Start > (All) Programs > ZyXEL PLA42xx Series Configuration > PLA42xx Series Configuration Utility**, or click on the icon on your desktop shown below.

Figure 21 Click on the PLA42xx Series Configuration Utility Icon



- 5 You are now ready to extend your powerline network or set up a second network.
 - See [Section 6.4 on page 39](#) to add a new powerline adapter to your network.
 - See [Section 6.5 on page 40](#) to set up a second network with your new adapters.
 - See [Section 6.6 on page 42](#) to set up a second network with your existing adapters.

6.4 Adding a Powerline Adapter

This section shows you how to add a new powerline adapter to expand your existing network.

The figure below shows the family computer with Internet access on a powerline network. Expand the network by adding a new powerline adapter connected to a printer.

Figure 22 Add a Printer to Your Powerline Network

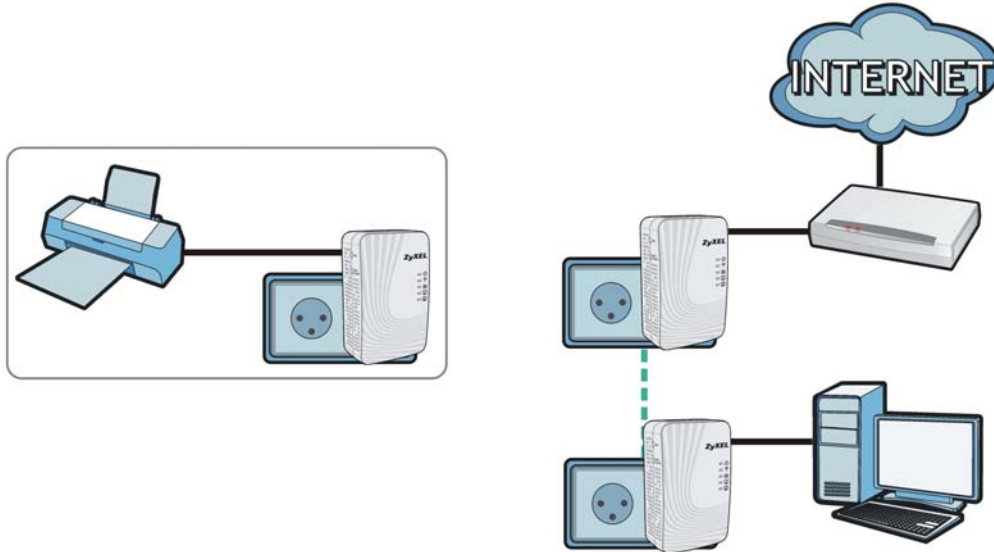

Note: You do not need to know the network name of the new adapter to add it to your network.

- 1 Connect your computer to the powerline adapter you want to add to your network and open the **PLA42xx Series Configuration Utility** (see [Section 6.3 on page 38](#)).
- 2 The utility should open to the configuration tab. On this screen in the **Site** column your new powerline adapter should appear as **Local** (**A**). Check the **Local** adapter's MAC address (**B**). It should match the MAC address listed on the label on the back of your powerline adapter.

Figure 23 Adding a New Adapter

The screenshot shows the 'Configuration' window of the PLA42xx Series Configuration Utility. The 'Network Topology' section is active, displaying a table of network devices. The table has three columns: 'Site', 'MAC Address', and 'DAK Password'. The first row shows a 'Local' site with a MAC address of '00:08:ED:0C:82:03'. Red boxes labeled 'A' and 'B' highlight the 'Local' site and the MAC address, respectively. Below the table, there are fields for 'DAK Password' and 'Network Name (NMK)', along with 'Save' and 'Write' buttons. A note at the bottom states: 'Note: You can find your MAC Address and DAK Password on your device's back label, and the password format should be "XXXX-XXXX-XXXX-XXXX".'

Site	MAC Address	DAK Password
Local	00:08:ED:0C:82:03	

- 3 Select your adapter by selecting **Local** and type the network name for your existing network in the **Network Name** field (C).

Figure 24 Adding an Adapter to an Existing Network

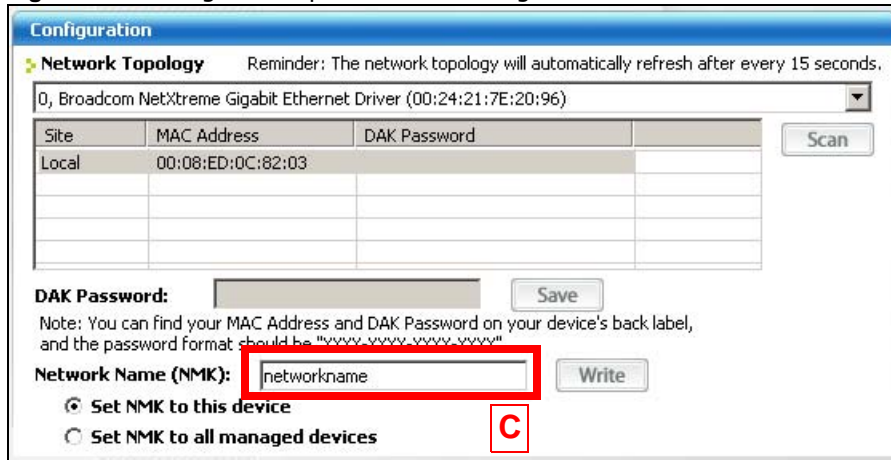

- 4 Click **Save** and click **OK** on the pop-up.

Figure 25 Network Name Pop-up



- 5 Your new adapter will now have the same **Network Name** as your existing network and so has now joined your existing network.
- 6 Connect the adapter to the device you want to add to the network, for example, your Internet refrigerator in the kitchen.
- 7 Plug the adapter's power cord into a power outlet and, if required, switch the power outlet on.
- 8 Repeat this procedure for all additional powerline adapters that you want to add to your existing or new powerline network.

6.5 Setting Up a New Network with a New Adapter

This section shows you how to use your new powerline adapters to set up a new powerline network separate to your existing network.

The figure below shows two powerline networks in a house. The first network (1) shows the home computer connected to a printer and access to the Internet. The second network (2) has no

Internet access but with a media adapter such as the ZyXEL DMA-1100P you can use your TV to watch movies and play games which are stored on a computer.

Figure 26 Add New Adapters to Make a Second Network

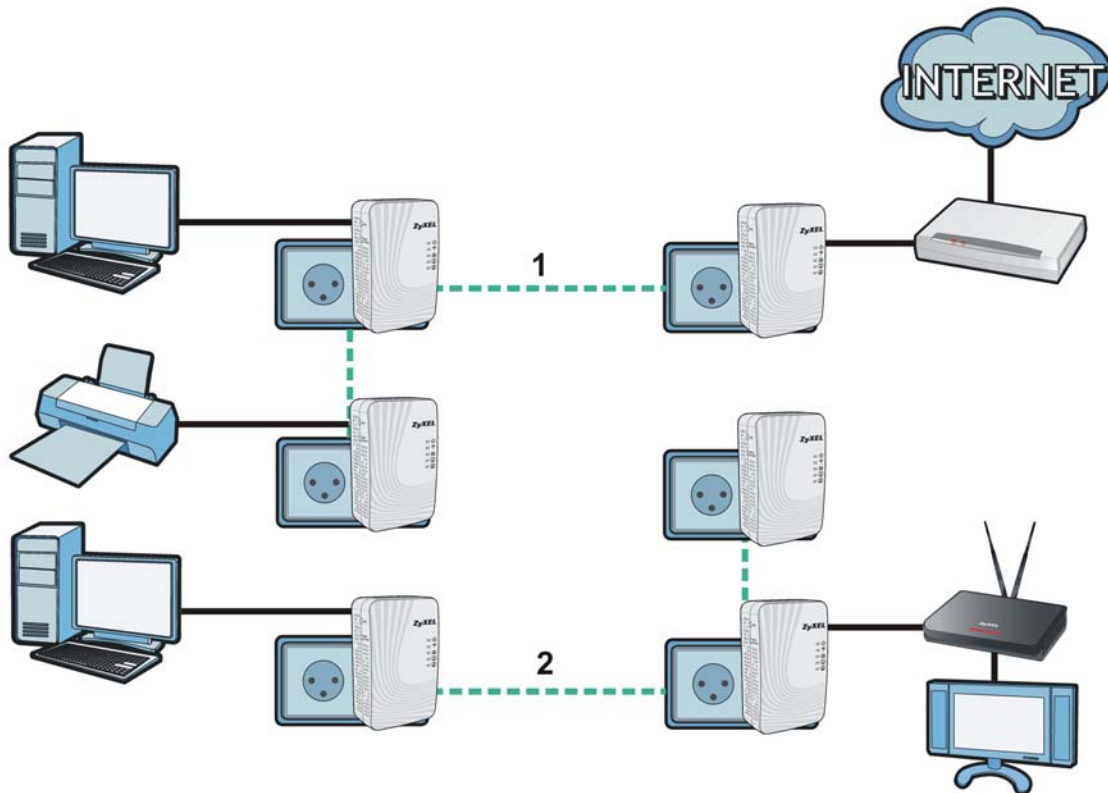

- 1 Connect your new powerline adapter and open the configuration utility as shown in [Section 6.5 on page 40](#). The screen shown below appears.
- 2 Type a **Network Name** that is different from the **Network Name** for your existing network. Make sure you use the same new **Network Name** for all new adapters you want to add to your new network.

Figure 27 Making a New Network with the New Adapter

Configuration

➤ **Network Topology** Reminder: The network topology will automatically refresh after every 15 seconds.

0, Broadcom NetXtreme Gigabit Ethernet Driver (00:24:21:7E:20:96)

Site	MAC Address	DAK Password
Local	00:08:ED:0C:82:03	

Scan

DAK Password: Save

Note: You can find your MAC Address and DAK Password on your device's back label, and the password format should be "xxxx xxxx xxxx xxxx".

Network Name (NMK): NEWnetworkname Write

Set NMK to this device

Set NMK to all managed devices

- 3 After you have set up a new network, you are ready to connect each powerline adapter on your new network to devices, for example, a computer or a games console.

6.6 Splitting a Network into Two Networks

This section shows you how to split your existing network into two networks. This is useful if you want to set up a second powerline network in your home, for example, in your study connecting a laptop and printer. See [Figure 26 on page 41](#) for an example.

To set up your existing powerline network you had to set each powerline adapter with the same network name. To move some of these adapters to a new network, you need to give them a new network name.

- 1 Connect a powerline adapter to your computer and open the **PLA42xx Series Configuration Utility** (see [Section 6.3 on page 38](#)).
- 2 The utility should open to the configuration tab as shown below. A list of powerline adapters on your network displays. These adapters all have the same network name as the adapter you are connected to. The adapter you are connected to will appear as **Local** in this table. All others are listed as **Remote**.

Figure 28 Local/Remote Adapters on a Powerline Network

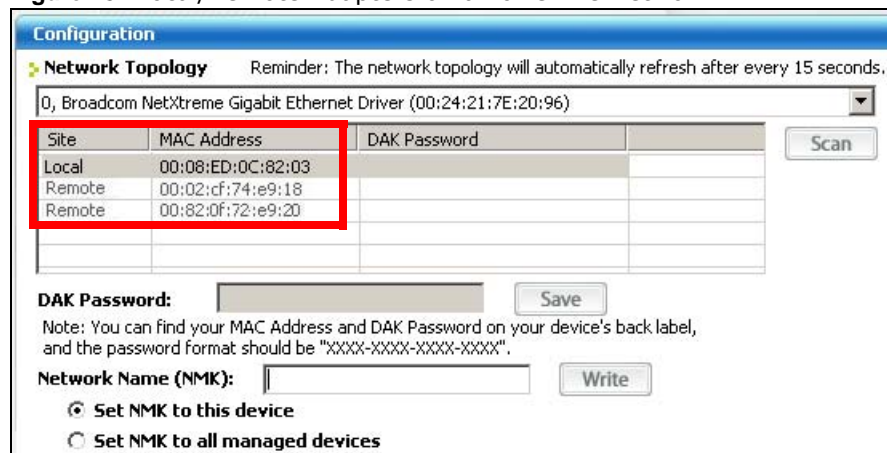

- 3 To set up a new powerline network, type the **DAK Password** and change the **Network Name** on all powerline adapters you wish to add to your network.
 - Look for the **DAK Password** on a label on your powerline adapter. The **DAK Password** lets you access the adapter.
 - Select the **Remote** adapter you want to add (**A**) and type the **DAK Password** in the **DAK Password** field (**B**).

- Then type the new network name in the **Network Name** field.

Figure 29 Adding an Adapter to Your New Network

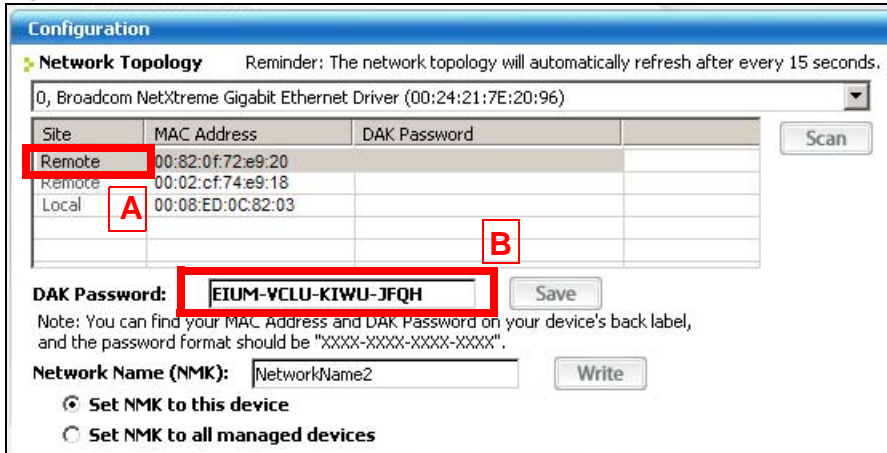

4 Click **Save**.

- If you do not type the **DAK password** or type it incorrectly either of the following pop-ups appear. Click **OK** and type the **DAK Password** correctly in the **DAK Password** field.

Figure 30 Incorrect DAK or No DAK



- If you have correctly entered the **DAK Password**, click **OK** on the pop-up.

Figure 31 Correct DAK



- The settings for the adapter will now grey out and the adapter will disappear from the table after a few minutes.

Figure 32 An Adapter on Your New Network

Configuration

Network Topology Reminder: The network topology will automatically refresh after every 15 seconds.

0, Broadcom NetXtreme Gigabit Ethernet Driver (00:24:21:7E:20:96)

Site	MAC Address	DAK Password
Remote	00:82:0f:72:e9:20	
Remote	00:02:cf:74:e9:18	
Local	00:08:ED:0C:82:03	

DAK Password: Save

Note: You can find your MAC Address and DAK Password on your device's back label, and the password format should be "XXXX-XXXX-XXXX-XXXX".

Network Name (NMK): Write

Set NMK to this device
 Set NMK to all managed devices

- Go back to step 3 in this section to set the same, new **Network Name** for all remote adapters you want to add to your new network.
- Check you have added the adapters correctly by changing the network name for the local adapter. All adapters with the new **Network Name** now appear in the list of adapters on your network. These adapters are now part of your new network.

Figure 33 Adapters on a New Powerline Network

Configuration

Network Topology Reminder: The network topology will automatically refresh after every 15 seconds.

0, Broadcom NetXtreme Gigabit Ethernet Driver (00:24:21:7E:20:96)

Site	MAC Address	DAK Password
Remote	00:82:0f:72:e9:20	
Remote	00:02:cf:74:e9:18	
Local	00:08:ED:0C:82:03	

DAK Password: Save

Note: You can find your MAC Address and DAK Password on your device's back label, and the password format should be "XXXX-XXXX-XXXX-XXXX".

Network Name (NMK): Write

Set NMK to this device
 Set NMK to all managed devices

- If you want to access any of your new powerline networks using the **PLA42xx Series Configuration Utility**, change the **Network Name** on your local adapter to the network name for the network you want to access. The adapters on that network will then display in the adapter table, allowing you to select and configure each one.

6.7 Troubleshooting

The HomePlug (🏠) LED (light) should light up on your adapter when it successfully connects to other adapters on your network. If it does not, try the following measures.

- Make sure the adapter is plugged in to a power socket and the power socket is turned on.

- Check you have entered the correct network name for your network.
- Check your powerline adapter is connected to the same electrical circuit as other powerline adapters on your network.

PART III

Web Configurator

Introducing the Web Configurator

7.1 Overview

This chapter describes how to access the PLA4231 Web Configurator and provides an overview of its screens.

The Web Configurator is an HTML-based management interface that allows easy setup and management of the PLA4231 via Internet browser. Use Internet Explorer 6.0 and later or Safari 2.0 or later versions. The recommended screen resolution is 1024 by 768 pixels.

In order to use the Web Configurator you need to allow:

- Web browser pop-up windows from your device. Web pop-up blocking is enabled by default in Windows XP SP (Service Pack) 2.
- JavaScripts (enabled by default).
- Java permissions (enabled by default).

Refer to the Troubleshooting chapter ([Chapter 14 on page 95](#)) to see how to make sure these functions are allowed in Internet Explorer.

7.2 Accessing the Web Configurator

- 1 Connect your computer to the LAN port of the PLA4231.
- 2 The default IP address of the PLA4231 is "192.168.1.2". In this case, your computer must have an IP address in the range between "192.168.1.3" and "192.168.1.254".
Click **Start > Run** on your computer in Windows. Type "cmd" in the dialog box. Enter "ipconfig" to show your computer's IP address. If your computer's IP address is not in the correct range then change your computer's IP address.
- 3 After you've set your computer's IP address, open a web browser such as Internet Explorer and type "http://192.168.1.2" as the web address in your web browser.

7.2.1 Login Screen

The Web Configurator initially displays the following login screen.

Figure 34 Login screen



The following table describes the labels in this screen.

Table 8 Login screen

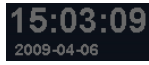
LABEL	DESCRIPTION
Language	Select the language you want to use to configure the Web Configurator. Click Login .
Password	Type "1234" (default) as the password.
	(This is just an example). This shows the current weather, either in celsius or fahrenheit, of the city you specify in Section 7.2.1.1 on page 50 .
	(This is just an example). This shows the time (hh:mm:ss) and date (yyyy:mm:dd) of the timezone you select in Section 7.2.1.2 on page 51 or Section 13.5 on page 88 . The time is in 24-hour format, for example 15:00 is 3:00 PM.

7.2.1.1 Weather Edit

You can change the temperature unit and select the location for which you want to know the weather.

Click the  icon to change the weather display.

Figure 35 Change Weather



The following table describes the labels in this screen.

Table 9 Change Weather

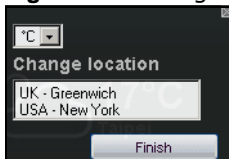
LABEL	DESCRIPTION
°C or °F	Choose which temperature unit you want the PLA4231 to display.
Change Location	Select the location for which you want to know the weather. If the city you want is not listed, choose one that is closest to it.
Finish	Click this to apply the settings and refresh the date and time display.

7.2.1.2 Time/Date Edit

One timezone can cover more than one country. You can choose a particular country in which the PLA4231 is located and have the PLA4231 display and use the current time and date for its logs.

Click the  icon to change the time and date display.

Figure 36 Change Time Zone

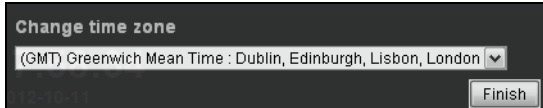

The following table describes the labels in this screen.

Table 10 Change Time Zone

LABEL	DESCRIPTION
Change time zone	Select the specific country whose current time and date you want the PLA4231 to display.
Finish	Click this to apply the settings and refresh the weather display.

Note: You can also edit the timezone in [Section 13.5 on page 88](#).

7.2.2 Password Screen

You should see a screen asking you to change your password (highly recommended) as shown next.

Figure 37 Change Password Screen

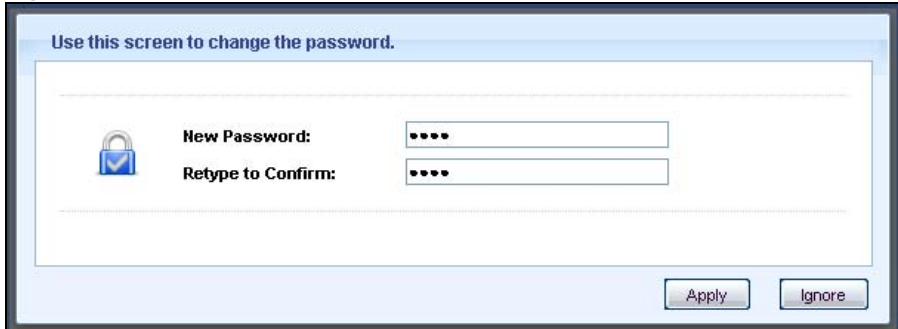

The following table describes the labels in this screen.

Table 11 Change Password Screen

LABEL	DESCRIPTION
New Password	Type a new password.
Retype to Confirm	Retype the password for confirmation.
Apply	Click Apply to save your changes back to the PLA4231.
Ignore	Click Ignore if you do not want to change the password this time.

Note: The management session automatically times out when the time period set in the **Administrator Inactivity Timer** field expires (default five minutes; go to [Chapter 13 on page 87](#) to change this). Simply log back into the PLA4231 if this happens.

Right after you log in, the **Dashboard** screen is displayed. See Chapter 4 on page 81 for more information about the **Dashboard** screen.

7.3 Navigating the Web Configurator

The following summarizes how to navigate the web configurator from the **Dashboard** screen.

Figure 38 Status Screen of the Web Configurator

The screenshot shows the ZyXEL PLA4231 Status Screen. The top bar (A) contains the ZyXEL logo, the device name PLA4231, and user information: Welcome: Admin | Logout | About. Below the top bar is a navigation sidebar (B) with icons for Home, Status, Configuration, and Tools. The main content area (C) is titled 'Status' and includes a 'Refresh Interval' dropdown set to 'None' and a 'Refresh Now' button. The main content is divided into three sections: 'Device Information', 'System Status', and 'Interface Status'. The 'Device Information' section lists various system parameters such as Host Name, Model Number, Firmware Version, and LAN/WLAN settings. The 'System Status' section shows System Up Time, Current Date/Time, and System Resource usage (CPU and Memory). The 'Interface Status' section shows the status and rate of the LAN and WLAN interfaces.

As illustrated above, the Web Configurator screen is divided into these parts:

- **A** - title bar
- **B** - navigation panel
- **C** - main window

7.3.1 Title Bar

Click **Logout** at any time to exit the Web Configurator.

Click **About** to open the about window, which provides information of the boot module and driver versions.

7.3.2 Navigation Panel

Use the menu items on the navigation panel to open screens to configure PLA4231 features. The following tables describe each menu item.

Table 12 Navigation Panel: Access Point Mode

LINK	TAB	FUNCTION
Dashboard		This screen shows the PLA4231's general device, system and interface status information. Use this screen to access the summary statistics tables.
MONITOR		
Log		Use this screen to view the list of activities recorded by your PLA4231.
Packet Statistics		Use this screen to view port status and packet specific statistics.
WLAN Station Status		Use this screen to view the wireless stations that are currently associated to the PLA4231.
CONFIGURATION		
Network		
Wireless LAN	General	Use this screen to configure general wireless LAN and wireless security settings.
	MAC Filter	Use the MAC filter screen to configure the PLA4231 to block access to devices or block the devices from accessing the PLA4231.
	Advanced	This screen allows you to configure advanced wireless settings.
	QoS	Use this screen to configure Wi-Fi Multimedia Quality of Service (WMM QoS). WMM QoS allows you to prioritize wireless traffic according to the delivery requirements of individual services.
	WPS	Use this screen to configure WPS.
	WPS Station	Use this screen to add a wireless station using WPS.
	Scheduling	Use this screen to schedule the times the Wireless LAN is enabled.
LAN	IP	Use this screen to configure LAN IP address and subnet mask.
	IP Alias	Use this screen to have the PLA4231 apply IP alias to create LAN subnets.
HomePlug	Powerline Setting	Use this screen to view and change powerline settings.
MAINTENANCE		
General		Use this screen to view and change administrative settings such as system and domain names.
Password	Password Setup	Use this screen to change the password of your PLA4231.
Time	Time Setting	Use this screen to change your PLA4231's time and date.

Table 12 Navigation Panel: Access Point Mode

LINK	TAB	FUNCTION
Firmware Upgrade		Use this screen to upload firmware to your PLA4231.
Backup/Restore		Use this screen to backup and restore the configuration or reset your PLA4231 to the factory defaults.
Restart	System Restart	This screen allows you to reboot the PLA4231 without turning the power off.
Language	Language	This screen allows you to select the language you prefer.

7.3.3 Main Window

The main window displays information and configuration fields. It is discussed in the rest of this document.

Dashboard

The **Dashboard** screens display when you log into the PLA4231, or click **Dashboard** in the navigation menu.

Use the **Dashboard** screen to look at the current status of the device, system resources, and interfaces. The **Dashboard** screens also provide detailed information about system statistics, associated wireless clients, and logs.

8.1 The Dashboard Screen

Use this screen to get a quick view of system, Ethernet, WLAN and other information regarding your PLA4231.

Click **Dashboard**. The following screen displays.

Figure 39 The Dashboard Screen

The screenshot shows the Dashboard screen for the PLA4231. At the top right, there is a 'Refresh Interval' dropdown menu set to 'None' and a 'Refresh Now' button. The main content is divided into several sections:

- Status**: A header section with a refresh interval dropdown and a 'Refresh Now' button.
- Device Information**: A table with two columns: 'Item' and 'Data'.

Item	Data
Host Name:	PLA4231
Firmware Version:	V1.00(AAGV.0)
Sys OP Mode:	AP Mode
LAN Information:	
- MAC Address:	00:12:0E:11:13:1B
- IP Address:	192.168.1.2
- IP Subnet Mask:	255.255.255.0
- Default Gateway:	
- DHCP:	None
WLAN Information:	
- WLAN OP Mode:	Access Point Mode
- MAC Address:	00:12:0E:11:13:1B
- SSID:	ZyXEL_4231
- Channel:	5
- Security:	WPA2-PSK
- 802.11 Mode:	802.11bgn
- WPS Status:	Configured
- System Status**: A table with two columns: 'Item' and 'Data'.

Item	Data
System Up Time:	0day 2hr 11min 9sec
Current Date/Time:	2012-11-27/14:11:44
System Resource:	
- CPU Usage:	4%
- Memory Usage:	60%
- Interface Status**: A table with three columns: 'Interface', 'Status', and 'Rate'.

Interface	Status	Rate
LAN	UP	100M
WLAN	UP	300M
- Summary**: A section with two links: 'Packet Statistics(Details...)' and 'WLAN Station Status(Details...)'.

The following table describes the labels in this screen.

Table 13 The Dashboard Screen

LABEL	DESCRIPTION
Refresh Interval	Select a number of seconds or None from the drop-down list box to refresh all screen statistics automatically at the end of every time interval or to not refresh the screen statistics.
Refresh Now	Click this button to refresh the status screen statistics.
Device Information	
Host Name	This is the PLA4231's model name.
Firmware Version	This is the firmware version and the date created.
Sys OP Mode	This is the device mode to which the PLA4231 is set - AP Mode .
LAN Information	
MAC Address	This shows the LAN Ethernet adapter MAC Address of your device.
IP Address	This shows the LAN port's IP address.
IP Subnet Mask	This shows the LAN port's subnet mask.
Default Gateway	This shows the gateway IP address.
DHCP	This shows the LAN port's DHCP role - Client or None .
WLAN Information	
WLAN OP Mode	This is the device mode to which the PLA4231's wireless LAN is set - Access Point Mode .
MAC Address	This shows the wireless adapter MAC Address of your device.
SSID	This shows a descriptive name used to identify the PLA4231 in the wireless LAN.
Channel	This shows the channel number which the PLA4231 is currently using over the wireless LAN.
Security	This shows the level of wireless security the PLA4231 is using.
802.11 Mode	This shows the wireless standard.
WPS Status	This displays Configured when the WPS has been set up. This displays Unconfigured if the WPS has not been set up.
Summary	
Packet Statistics	Click Details... to go to the Monitor > Packet Statistics screen (Section 9.4 on page 80). Use this screen to view port status and packet specific statistics.
WLAN Station Status	Click Details... to go to the Monitor > WLAN Station Status screen (Section 9.5 on page 81). Use this screen to view the wireless stations that are currently associated to the PLA4231.
System Status	
Item	This column shows the type of data the PLA4231 is recording.
Data	This column shows the actual data recorded by the PLA4231.
System Up Time	This is the total time the PLA4231 has been on.
Current Date/Time	This field displays your PLA4231's present date and time.
System Resource	
CPU Usage	This displays what percentage of the PLA4231's processing ability is currently used. When this percentage is close to 100%, the PLA4231 is running at full load, and the throughput is not going to improve anymore. If you want some applications to have more throughput, you should turn off other applications (for example, using bandwidth management).
Memory Usage	This shows what percentage of the heap memory the PLA4231 is using.
Interface Status	
Interface	This displays the PLA4231 port types. The port types are: LAN and WLAN .

Table 13 The Dashboard Screen

LABEL	DESCRIPTION
Status	For the LAN ports, this field displays Down (line is down) or Up (line is up or connected). For the WLAN, it displays Up when the WLAN is enabled or Down when the WLAN is disabled.
Rate	For the LAN ports, this displays the port speed or N/A when the line is disconnected. For the WLAN, it displays the maximum transmission rate when the WLAN is enabled and N/A when the WLAN is disabled.

Monitor

9.1 Overview

This chapter discusses read-only information related to the device state of the PLA4231.

Note: To access the Monitor screens, you can also click the links in the Summary table of the Status screen to view the packets sent/received as well as the status of clients connected to the PLA4231.

9.2 What You Can Do

- Use the **Log** screen ([Section 9.3 on page 59](#)) to view the logs for the categories such as system maintenance, system errors, and so on.
- use the **Packet Statistics** screen ([Section 9.4 on page 60](#)) to view port status, packet specific statistics, the "system up time" and so on.
- Use the **WLAN Station Status** screen ([Section 9.5 on page 61](#)) to view the wireless stations that are currently associated to the PLA4231.

9.3 Log

Use the **View Log** screen to see the logged messages for the PLA4231.

Log entries in red indicate system error logs. The log wraps around and deletes the old entries after it fills.

Click **Monitor > Log**.

Figure 40 Monitor > View Log



The following table describes the labels in this screen.

Table 14 Monitor > Log

LABEL	DESCRIPTION
Display	Select what logs you want to see from the Display drop list. The log choices depend on your settings in the Log Setting screen.
Refresh	Click Refresh to renew the log screen.
Clear	Click Clear to delete all the logs.
#	This field is a sequential value and is not associated with a specific entry.
Time	This field displays the time the log was recorded.
Message	This field states the reason for the log.

You can configure which logs to display in the **View Log** screen. Go to the **Log Setting** screen and select the logs you wish to display. Click **Apply** to save your settings. Click **Cancel** to start the screen afresh.

Figure 41 Monitor > Log Setting

9.4 Packet Statistics

Click the **Packet Statistics (Details...)** hyperlink in the **Dashboard** screen or **Monitor > Packet Statistics**. Read-only information here includes port status, packet specific statistics and the "system up time". The **Poll Interval(s)** field is configurable and is used for refreshing the screen.

Figure 42 Monitor > Packet Statistics

Port	Status	TxPkts	RxPkts	Collisions	Tx B/s	Rx B/s	Up Time
LAN	100M	2444	2482	0	107	26	3: 46: 25
WLAN	300M	21815	3899	0	578	49	3: 46: 25

System Up Time : 3: 46: 25
 Poll Interval(s) : None [v] [Set Interval] [Stop]

The following table describes the labels in this screen.

Table 15 Monitor > Packet Statistics

LABEL	DESCRIPTION
Port	This is the PLA4231's interface type.
Status	For the LAN port, this displays the port speed or Down when the line is disconnected. For the WLAN, it displays the maximum transmission rate when the WLAN is enabled and Down when the WLAN is disabled.
TxPkts	This is the number of transmitted packets on this port.
RxPkts	This is the number of received packets on this port.
Collisions	This is the number of collisions on this port.
Tx B/s	This displays the transmission speed in bytes per second on this port.
Rx B/s	This displays the reception speed in bytes per second on this port.
Up Time	This is the total time the PLA4231 has been for each session.
System Up Time	This is the total time the PLA4231 has been on.
Poll Interval(s)	Enter the time interval in seconds for refreshing statistics in this field.
Set Interval	Click this button to apply the new poll interval you entered in the Poll Interval(s) field.
Stop	Click Stop to stop refreshing statistics.

9.5 WLAN Station Status

Click the **WLAN Station Status (Details...)** hyperlink in the **Dashboard** screen or **Monitor > WLAN Station Status**. View the wireless stations that are currently associated to the PLA4231 in the **Association List**. Association means that a wireless client (for example, your network or computer with a wireless network card) has connected successfully to the AP (or wireless router) using the same SSID, channel and security settings.

Figure 43 Monitor > WLAN Station Status

The screenshot shows a web interface titled "Association List". It contains a table with the following data:

#	MAC Address	Association Time
1	00:19:cb:32:be:ac	13:03:44 2012/10/14

The following table describes the labels in this screen.

Table 16 Monitor > WLAN Station Status

LABEL	DESCRIPTION
#	This is the index number of an associated wireless station.
MAC Address	This field displays the MAC address of an associated wireless station.
Association Time	This field displays the time a wireless station first associated with the PLA4231's WLAN network.

Wireless LAN

10.1 Overview

This chapter discusses how to configure the wireless network settings in your PLA4231. See the appendices for more detailed information about wireless networks.

The following figure provides an example of a wireless network.

Figure 44 Example of a Wireless Network

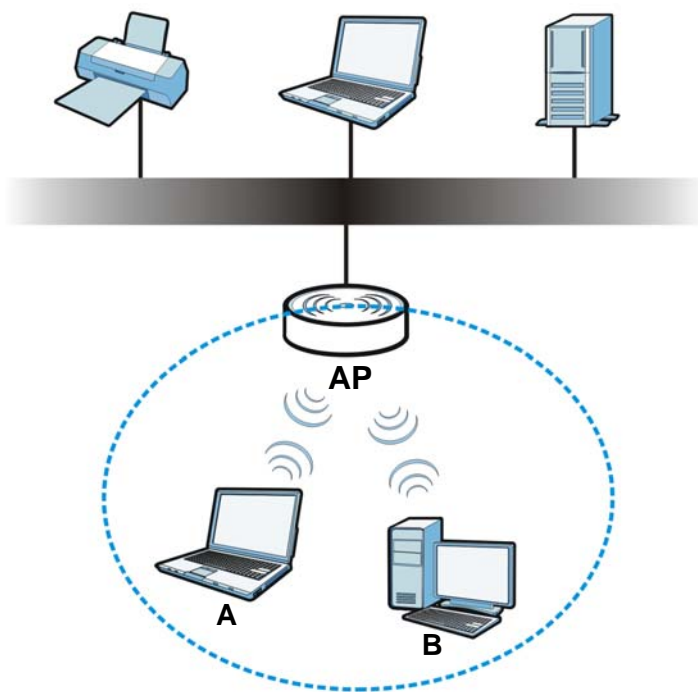

The wireless network is the part in the blue circle. In this wireless network, devices **A** and **B** are called wireless clients. The wireless clients use the access point (AP) to interact with other devices (such as the printer) or with the Internet. Your PLA4231 is the AP.

10.2 What You Can Do

- Use the **General** screen ([Section 10.4 on page 66](#)) to turn the wireless connection on or off, enter the SSID, select the channel, and configure wireless security between the PLA4231 and the wireless clients.
- Use the **MAC Filter** screen ([Section 10.6 on page 71](#)) to allow or deny wireless stations based on their MAC addresses from connecting to the PLA4231.

- Use the **Advanced** screen ([Section 10.7 on page 73](#)) to configure wireless advanced features, such as set the RTS/CTS Threshold and HT physical mode.
- Use the **QoS** screen ([Section 10.8 on page 73](#)) to enable Wifi MultiMedia Quality of Service (WMMQoS). This allows the PLA4231 to automatically set priority levels to services, such as e-mail, VoIP, chat, and so on.
- Use the **WPS** screen ([Section 10.9 on page 74](#)) to quickly set up a wireless network with strong security, without having to configure security settings manually.
- Use the **WPS Station** screen ([Section 10.10 on page 76](#)) to add a wireless station using WPS.
- Use the **Scheduling** screen ([Section 10.11 on page 76](#)) to set the times your wireless LAN is turned on and off.

10.3 What You Should Know

Every wireless network must follow these basic guidelines.

- Every wireless client in the same wireless network must use the same SSID.
The SSID is the name of the wireless network. It stands for Service Set IDentity.
- If two wireless networks overlap, they should use different channels.
Like radio stations or television channels, each wireless network uses a specific channel, or frequency, to send and receive information.
- Every wireless client in the same wireless network must use security compatible with the AP.
Security stops unauthorized devices from using the wireless network. It can also protect the information that is sent in the wireless network.

10.3.1 Wireless Security Overview

The following sections introduce different types of wireless security you can set up in the wireless network.

10.3.1.1 SSID

Normally, the AP acts like a beacon and regularly broadcasts the SSID in the area. You can hide the SSID instead, in which case the AP does not broadcast the SSID. In addition, you should change the default SSID to something that is difficult to guess.

This type of security is fairly weak, however, because there are ways for unauthorized devices to get the SSID. In addition, unauthorized devices can still see the information that is sent in the wireless network.

10.3.1.2 MAC Address Filter

Every wireless client has a unique identification number, called a MAC address.¹ A MAC address is usually written using twelve hexadecimal characters²; for example, 00A0C5000002 or 00:A0:C5:00:00:02. To get the MAC address for each wireless client, see the appropriate User's Guide or other documentation.

1. Some wireless devices, such as scanners, can detect wireless networks but cannot use wireless networks. These kinds of wireless devices might not have MAC addresses.
2. Hexadecimal characters are 0, 1, 2, 3, 4, 5, 6, 7, 8, 9, A, B, C, D, E, and F.

You can use the MAC address filter to tell the AP which wireless clients are allowed or not allowed to use the wireless network. If a wireless client is allowed to use the wireless network, it still has to have the correct settings (SSID, channel, and security). If a wireless client is not allowed to use the wireless network, it does not matter if it has the correct settings.

This type of security does not protect the information that is sent in the wireless network. Furthermore, there are ways for unauthorized devices to get the MAC address of an authorized wireless client. Then, they can use that MAC address to use the wireless network.

Encryption

Wireless networks can use encryption to protect the information that is sent in the wireless network. Encryption is like a secret code. If you do not know the secret code, you cannot understand the message.

Table 17 Types of Encryption

Weakest	No Security
↕	Static WEP
↕	WPA-PSK
Strongest	WPA2-PSK

Usually, you should set up the strongest encryption that every wireless client in the wireless network supports. For example, suppose the AP does not have a local user database, and you do not have a RADIUS server. Therefore, there is no user authentication. Suppose the wireless network has two wireless clients. Device A only supports WEP, and device B supports WEP and WPA. Therefore, you should set up **Static WEP** in the wireless network.

Note: It is recommended that wireless networks use **WPA-PSK** or stronger encryption. WEP encryption are better than none at all, but it is still possible for unauthorized devices to figure out the original information pretty quickly.

When you select **WPA2-PSK** in your PLA4231, you can also select an option (**WPA-PSK Compatible**) to support WPA as well. In this case, if some wireless clients support WPA and some support WPA2, you should set up **WPA2-PSK** and select the **WPA-PSK Compatible** option in the PLA4231.

Many types of encryption use a key to protect the information in the wireless network. The longer the key, the stronger the encryption. Every wireless client in the wireless network must have the same key.

10.3.1.3 WPS

WiFi Protected Setup (WPS) is an industry standard specification, defined by the WiFi Alliance. WPS allows you to quickly set up a wireless network with strong security, without having to configure security settings manually. Depending on the devices in your network, you can either press a button (on the device itself, or in its configuration utility) or enter a PIN (Personal Identification Number) in the devices. Then, they connect and set up a secure network by themselves.

10.4 General Wireless LAN Screen

Use this screen to enable or disable the WLAN, enter the SSID, select the channel and configure wireless security settings.

Note: If you are configuring the PLA4231 from a computer connected to the wireless LAN and you change the PLA4231's SSID, channel or security settings, you will lose your wireless connection when you press **Apply** to confirm. You must then change the wireless settings of your computer to match the PLA4231's new settings.

Click **Network > Wireless LAN** to open the **General** screen.

Figure 45 Network > Wireless LAN > General

The following table describes the general wireless LAN labels in this screen.

Table 18 Network > Wireless LAN > General

LABEL	DESCRIPTION
Wireless Setup	
Wireless LAN	Select to enable or disable the wireless LAN. This is turned on by default.
Name (SSID)	The SSID (Service Set IDentity) identifies the Service Set with which a wireless client is associated. Enter a descriptive name (up to 32 printable characters found on a typical English language keyboard) for the wireless LAN.
Hide SSID	Select this check box to hide the SSID in the outgoing beacon frame so a wireless client cannot obtain the SSID through scanning using a site survey tool.
Channel Selection	Set the operating frequency/channel depending on your particular region. Select a channel from the drop-down list box. The options vary depending on the frequency band and the country you are in. This option is only available if Auto Channel Selection is disabled.
Auto Channel Selection	Select the check box to have the PLA4231 automatically scan for and select a channel which is not used by another device.

Table 18 Network > Wireless LAN > General

LABEL	DESCRIPTION
Operating Channel	This displays the channel the PLA4231 is currently using.
Channel Width	<p>Select the wireless channel width used by PLA4231.</p> <p>A standard 20 MHz channel offers transfer speeds of up to 150Mbps whereas a 40 MHz channel uses two standard channels and offers speeds of up to 300 Mbps.</p> <p>Because not all devices support 40 MHz channels, select Auto 20/40 MHz to allow the PLA4231 to adjust the channel bandwidth automatically.</p> <p>40 MHz (channel bonding or dual channel) bonds two adjacent radio channels to increase throughput. The wireless clients must also support 40 MHz. It is often better to use the 20 MHz setting in a location where the environment hinders the wireless signal.</p> <p>Select 20 MHz if you want to lessen radio interference with other wireless devices in your neighborhood or the wireless clients do not support channel bonding.</p>
802.11 Mode	<p>You can select from the following:</p> <ul style="list-style-type: none"> • 802.11b: allows either IEEE 802.11b or IEEE 802.11g compliant WLAN devices to associate with the PLA4231. In this mode, all wireless devices can only transmit at the data rates supported by IEEE 802.11b. • 802.11g: allows IEEE 802.11g compliant WLAN devices to associate with the Device. IEEE 802.11b compliant WLAN devices can associate with the PLA4231 only when they use the short preamble type. • 802.11bg: allows either IEEE 802.11b or IEEE 802.11g compliant WLAN devices to associate with the PLA4231. The PLA4231 adjusts the transmission rate automatically according to the wireless standard supported by the wireless devices. • 802.11n: allows IEEE 802.11n compliant WLAN devices to associate with the PLA4231. This can increase transmission rates, although IEEE 802.11b or IEEE 802.11g clients will not be able to connect to the PLA4231. I • 802.11gn: allows either IEEE 802.11g or IEEE 802.11n compliant WLAN devices to associate with the PLA4231. The transmission rate of your PLA4231 might be reduced. • 802.11 bgn: allows IEEE802.11b, IEEE802.11g and IEEE802.11n compliant WLAN devices to associate with the PLA4231. The transmission rate of your PLA4231 might be reduced.
Security Mode	<p>Select Static WEP, WPA-PSK, or WPA2-PSK to add security on this wireless network. The wireless clients which want to associate to this network must have same wireless security settings as this device. After you select to use a security, additional options appears in this screen. See Section 10.5 on page 67 for detailed information on different security modes. Or you can select No Security to allow any client to associate this network without authentication.</p> <p>Note: If the WPS function is enabled (default), only No Security and WPA2-PSK are available in this field.</p>
Apply	Click Apply to save your changes back to the PLA4231.
Cancel	Click Cancel to reload the previous configuration for this screen.

10.5 Wireless Security

The screen varies depending on what you select in the **Security Mode** field.

10.5.1 No Security

Select **No Security** to allow wireless clients to communicate with the access points without any data encryption.

Note: If you do not enable any wireless security on your PLA4231, your network is accessible to any wireless networking device that is within range.

Figure 46 Network > Wireless LAN > Security: No Security

The following table describes the labels in this screen.

Table 19 Network > Wireless LAN > Security: No Security

LABEL	DESCRIPTION
Security Mode	Choose No Security from the drop-down list box.
Apply	Click Apply to save your changes back to the PLA4231.
Cancel	Click Cancel to reload the previous configuration for this screen.

10.5.2 WEP Encryption

WEP encryption scrambles the data transmitted between the wireless stations and the access points to keep network communications private. It encrypts unicast and multicast communications in a network. Both the wireless stations and the access points must use the same WEP key.

Your PLA4231 allows you to configure up to four 64-bit or 128-bit WEP keys but only one key can be enabled at any one time.

Select **Static WEP** from the **Security Mode** list.

Figure 47 Network > Wireless LAN > Security: Static WEP

Wireless Setup

Wireless LAN : Enable Disable

Name (SSID) :

Hide SSID

Channel Selection : Auto Channel Selection

Operating Channel :

Channel Width :

Channel Mode :

Security

Security Mode :

PassPhrase :

WEP Encryption :

Authentication Method :

Note:

64-bit WEP: Enter 5 ASCII characters or 10 hexadecimal characters ("0-9", "A-F") for each Key (1-4).
 128-bit WEP: Enter 13 ASCII characters or 26 hexadecimal characters ("0-9", "A-F") for each Key (1-4).
 (Select one WEP key as an active key to encrypt wireless data transmission.)

ASCII Hex

Key 1

Key 2

Key 3

Key 4

Note: No Security and WPA2-PSK can be configured when WPS enabled.

The following table describes the wireless LAN security labels in this screen.

Table 20 Network > Wireless LAN > Security: Static WEP

LABEL	DESCRIPTION
Security Mode	Select Static WEP to enable data encryption.
PassPhrase	Enter a passphrase (up to 26 printable characters) and click Generate . A passphrase functions like a password. In WEP security mode, it is further converted by the PLA4231 into a complicated string that is referred to as the "key". This key is requested from all devices wishing to connect to a wireless network.
WEP Encryption	Select 64-bits or 128-bits . This dictates the length of the security key that the network is going to use.
Authentication Method	Select Auto or Shared Key from the drop-down list box. This field specifies whether the wireless clients have to provide the WEP key to login to the wireless client. Keep this setting at Auto unless you want to force a key verification before communication between the wireless client and the PLA4231 occurs. Select Shared Key to force the clients to provide the WEP key prior to communication.
ASCII	Select this option in order to enter ASCII characters as WEP key.

Table 20 Network > Wireless LAN > Security: Static WEP

LABEL	DESCRIPTION
Hex	Select this option in order to enter hexadecimal characters as a WEP key. The preceding "0x", that identifies a hexadecimal key, is entered automatically.
Key 1 to Key 4	The WEP keys are used to encrypt data. Both the PLA4231 and the wireless stations must use the same WEP key for data transmission. If you chose 64-bit WEP , then enter any 5 ASCII characters or 10 hexadecimal characters ("0-9", "A-F"). If you chose 128-bit WEP , then enter 13 ASCII characters or 26 hexadecimal characters ("0-9", "A-F"). You must configure at least one key, only one key can be activated at any one time. The default key is key 1.
Apply	Click Apply to save your changes back to the PLA4231.
Cancel	Click Cancel to reload the previous configuration for this screen.

10.5.3 WPA-PSK/WPA2-PSK

Select **WPA-PSK** or **WPA2-PSK** from the **Security Mode** list.

Figure 48 Network > Wireless LAN > Security: WPA2-PSK

The screenshot displays the configuration interface for WPA2-PSK security. It includes tabs for General, MAC Filter, Advanced, QoS, WPS, WPS Station, and Scheduling. The 'Wireless Setup' section shows 'Wireless LAN' enabled, SSID 'ZyXEL', and channel settings. The 'Security' section shows 'Security Mode' set to 'WPA2-PSK', 'WPA-PSK Compatible' checked, and a 'Pre-Shared Key' of '1234567890'. A note at the bottom states: 'Note: No Security and WPA2-PSK can be configured when WPS enabled.' Buttons for 'Apply' and 'Cancel' are at the bottom.

The following table describes the labels in this screen.

Table 21 Network > Wireless LAN > Security: WPA-PSK/WPA2-PSK

LABEL	DESCRIPTION
Security Mode	Select WPA-PSK or WPA2-PSK to enable data encryption.
WPA-PSK Compatible	This field appears when you choose WPA2-PSK as the Security Mode . Check this field to allow wireless devices using WPA-PSK security mode to connect to your PLA4231.
Pre-Shared Key	WPA-PSK/WPA2-PSK uses a simple common password for authentication. Type a pre-shared key from 8 to 63 case-sensitive keyboard characters.
Group Key Update Timer	The Group Key Update Timer is the rate at which the AP sends a new group key out to all clients. The default is 3600 seconds (60 minutes).
Apply	Click Apply to save your changes back to the PLA4231.
Cancel	Click Cancel to reload the previous configuration for this screen.

10.6 MAC Filter

The MAC filter screen allows you to configure the PLA4231 to give exclusive access to devices (Allow) or exclude devices from accessing the PLA4231 (Deny). Every Ethernet device has a unique MAC (Media Access Control) address. The MAC address is assigned at the factory and consists of six pairs of hexadecimal characters, for example, 00:A0:C5:00:00:02. You need to know the MAC address of the devices to configure this screen.

To change your PLA4231's MAC filter settings, click **Network > Wireless LAN > MAC Filter**. The screen appears as shown.

Figure 49 Network > Wireless LAN > MAC Filter

MAC Address Filter : Enable Disable

Filter Action : Allow Deny

MAC Filter Summary			
Set	MAC Address	Set	MAC Address
1	00:00:00:00:00:00	17	00:00:00:00:00:00
2	00:00:00:00:00:00	18	00:00:00:00:00:00
3	00:00:00:00:00:00	19	00:00:00:00:00:00
4	00:00:00:00:00:00	20	00:00:00:00:00:00
5	00:00:00:00:00:00	21	00:00:00:00:00:00
6	00:00:00:00:00:00	22	00:00:00:00:00:00
7	00:00:00:00:00:00	23	00:00:00:00:00:00
8	00:00:00:00:00:00	24	00:00:00:00:00:00
9	00:00:00:00:00:00	25	00:00:00:00:00:00
10	00:00:00:00:00:00	26	00:00:00:00:00:00
11	00:00:00:00:00:00	27	00:00:00:00:00:00
12	00:00:00:00:00:00	28	00:00:00:00:00:00
13	00:00:00:00:00:00	29	00:00:00:00:00:00
14	00:00:00:00:00:00	30	00:00:00:00:00:00
15	00:00:00:00:00:00	31	00:00:00:00:00:00
16	00:00:00:00:00:00	32	00:00:00:00:00:00

Apply Cancel

The following table describes the labels in this menu.

Table 22 Network > Wireless LAN > MAC Filter

LABEL	DESCRIPTION
MAC Address Filter	Select to turn on (Enable) or off (Disable) MAC address filtering.
Filter Action	Define the filter action for the list of MAC addresses in the MAC Filter Summary table. Select Allow to permit access to the PLA4231, MAC addresses not listed will be denied access to the PLA4231. Select Deny to block access to the PLA4231, MAC addresses not listed will be allowed to access the PLA4231.
MAC Filter Summary	
Set	This is the index number of the MAC address.
MAC Address	Enter the MAC address of the wireless station that are allowed or denied access to the PLA4231.
Apply	Click Apply to save your changes back to the PLA4231.
Cancel	Click Cancel to reload the previous configuration for this screen.

10.7 Wireless LAN Advanced Screen

Use this screen to allow wireless advanced features, such as the output power, and RTS/CTS Threshold.

Click **Network > Wireless LAN > Advanced**. The screen appears as shown.

Figure 50 Network > Wireless LAN > Advanced

The screenshot shows the 'Wireless Advanced Setup' screen with the following fields and controls:

- RTS/CTS Threshold:** Input field with value 2345 and range (256 ~ 2345).
- Fragmentation Threshold:** Input field with value 2345 and range (256 ~ 2345).
- Intra-BSS Traffic:** Radio buttons for Enable and Disable.
- Tx Power:** Dropdown menu with value 100%.
- Buttons:** Apply and Cancel buttons at the bottom.

The following table describes the labels in this screen.

Table 23 Network > Wireless LAN > Advanced

LABEL	DESCRIPTION
RTS/CTS Threshold	Data with its frame size larger than this value will perform the RTS (Request To Send)/CTS (Clear To Send) handshake. Note: If you select 802.11n , 802.11gn or 802.11bgn in the Wireless LAN > General screen, this field is not configurable and the PLA4231 automatically changes to use the maximum value.
Fragmentation Threshold	The threshold (number of bytes) for the fragmentation boundary for directed messages. It is the maximum data fragment size that can be sent. Note: If you select 802.11n , 802.11gn or 802.11bgn in the Wireless LAN > General screen, this field is not configurable and the PLA4231 automatically changes to use the maximum value.
Intra-BSS Traffic	A Basic Service Set (BSS) exists when all communications between wireless clients or between a wireless client and a wired network client go through one access point (AP). Intra-BSS traffic is traffic between wireless clients in the BSS. When Intra-BSS traffic is enabled, wireless clients can access the wired network and communicate with each other. When Intra-BSS traffic is disabled, wireless clients can still access the wired network but cannot communicate with each other.
Tx Power	Set the output power of the PLA4231 in this field. If there is a high density of APs in an area, decrease the output power of the PLA4231 to reduce interference with other APs. Select one of the following 100% , 90% , 75% , 50% , 25% or 10% .
Apply	Click Apply to save your changes back to the PLA4231.
Cancel	Click Cancel to reload the previous configuration for this screen.

10.8 Quality of Service (QoS) Screen

The QoS screen allows you to automatically give a service (such as VoIP and video) a priority level.

Click **Network > Wireless LAN > QoS**. The following screen appears.

Figure 51 Network > Wireless LAN > QoS

The screenshot shows a configuration window with tabs: General, MAC Filter, Advanced, QoS (selected), WPS, WPS Station, and Scheduling. Under 'WMM QoS', there are radio buttons for 'Enable' (selected) and 'Disable'. Below this is a 'Note' icon and text: 'When the wireless mode contains N mode, wmm support will be enabled automatically.' At the bottom are 'Apply' and 'Cancel' buttons.

The following table describes the labels in this screen.

Table 24 Network > Wireless LAN > QoS

LABEL	DESCRIPTION
WMM QoS	Select Enable to have the PLA4231 automatically give a service a priority level according to the ToS value in the IP header of packets it sends. WMM QoS (Wifi MultiMedia Quality of Service) gives high priority to voice and video, which makes them run more smoothly. Note: If you select 802.11n , 802.11gn or 802.11bgn in the Wireless LAN > General screen, this field is not configurable and the PLA4231 automatically enables WMM QoS.
Apply	Click Apply to save your changes to the PLA4231.
Cancel	Click Cancel to reload the previous configuration for this screen.

10.9 WPS Screen

Use this screen to enable/disable WPS, view or generate a new PIN number and check current WPS status. To open this screen, click **Network > Wireless LAN > WPS** tab.

Figure 52 Network > Wireless LAN > WPS

The following table describes the labels in this screen.

Table 25 Network > Wireless LAN > WPS

LABEL	DESCRIPTION
WPS Setup	
WPS	Select Enable to turn on the WPS feature. Otherwise, select Disable .
PIN Code	Select Enable and click Apply to allow the PIN Configuration method. If you select Disable , you cannot create a new PIN number.
PIN Number	This is the WPS PIN (Personal Identification Number) of the PLA4231. Enter this PIN in the configuration utility of the device you want to connect to the PLA4231 using WPS. The PIN is not necessary when you use WPS push-button method. Click Generate to generate a new PIN number.
Status	
Status	This displays Configured when the PLA4231 has connected to a wireless network using WPS or when Enable WPS is selected and wireless or wireless security settings have been changed. The current wireless and wireless security settings also appear in the screen. This displays Unconfigured if WPS is disabled and there are no wireless or wireless security changes on the PLA4231 or you click Release_Configuration to remove the configured wireless and wireless security settings.
Release Configuration	This button is only available when the WPS status displays Configured . Click this button to remove all configured wireless and wireless security settings for WPS connections on the PLA4231.
802.11 Mode	This is the 802.11 mode used. Only compliant WLAN devices can associate with the PLA4231.
SSID	This is the name of the wireless network (the PLA4231's first SSID).
Security	This is the type of wireless security employed by the network.
Apply	Click Apply to save your changes back to the PLA4231.
Cancel	Click Cancel to reload the previous configuration for this screen.

10.10 WPS Station Screen

Use this screen when you want to add a wireless station using WPS. To open this screen, click **Network > Wireless LAN > WPS Station** tab.

Note: After you click **Push Button** on this screen, you have to press a similar button in the wireless station utility within 2 minutes. To add the second wireless station, you have to press these buttons on both device and the wireless station again after the first 2 minutes.

Figure 53 Network > Wireless LAN > WPS Station

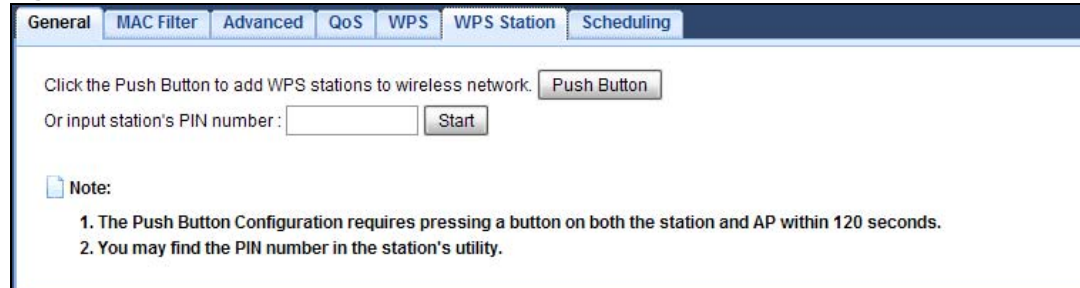

The following table describes the labels in this screen.

Table 26 Network > Wireless LAN > WPS Station

LABEL	DESCRIPTION
Push Button	Use this button when you use the PBC (Push Button Configuration) method to configure wireless stations's wireless settings. Click this to start WPS-aware wireless station scanning and the wireless security information synchronization.
Or input station's PIN number	Use this button when you use the PIN Configuration method to configure wireless station's wireless settings. Type the same PIN number generated in the wireless station's utility. Then click Start to associate to each other and perform the wireless security information synchronization.

10.11 Scheduling Screen

Use this screen to set the times your wireless LAN is turned on and off. Wireless LAN scheduling is disabled by default. The wireless LAN can be scheduled to turn on or off on certain days and at certain times. To open this screen, click **Network > Wireless LAN > Scheduling** tab.

Figure 54 Network > Wireless LAN > Scheduling

Wireless LAN Scheduling : Enable Disable

Scheduling		
WLAN status	Day	For the following times (24-Hour Format)
<input checked="" type="radio"/> On <input type="radio"/> Off	<input type="checkbox"/> Everyday	00 (hour) 00 (min) ~ 00 (hour) 00 (min)
<input type="radio"/> On <input checked="" type="radio"/> Off	<input checked="" type="checkbox"/> Mon	00 (hour) 00 (min) ~ 00 (hour) 00 (min)
<input type="radio"/> On <input checked="" type="radio"/> Off	<input checked="" type="checkbox"/> Tue	00 (hour) 00 (min) ~ 00 (hour) 00 (min)
<input type="radio"/> On <input checked="" type="radio"/> Off	<input checked="" type="checkbox"/> Wed	00 (hour) 00 (min) ~ 00 (hour) 00 (min)
<input type="radio"/> On <input checked="" type="radio"/> Off	<input checked="" type="checkbox"/> Thu	00 (hour) 00 (min) ~ 00 (hour) 00 (min)
<input type="radio"/> On <input checked="" type="radio"/> Off	<input checked="" type="checkbox"/> Fri	00 (hour) 00 (min) ~ 00 (hour) 00 (min)
<input type="radio"/> On <input checked="" type="radio"/> Off	<input type="checkbox"/> Sat	00 (hour) 00 (min) ~ 00 (hour) 00 (min)
<input type="radio"/> On <input checked="" type="radio"/> Off	<input type="checkbox"/> Sun	00 (hour) 00 (min) ~ 00 (hour) 00 (min)

Note:
Specify the same begin time and end time means the whole day schedule.

Apply Cancel

The following table describes the labels in this screen.

Table 27 Network > Wireless LAN > Scheduling

LABEL	DESCRIPTION
Wireless LAN Scheduling	Select Enable to activate the wireless LAN scheduling feature. Select Disable to turn it off.
Scheduling	
WLAN Status	Select On or Off to specify whether the Wireless LAN is turned on or off. This field works in conjunction with the Day and For the following times fields.
Day	Select Everyday or the specific days to turn the Wireless LAN on or off. If you select Everyday you can not select any specific days. This field works in conjunction with the For the following times field.
For the following times (24-Hour Format)	Select a begin time using the first set of hour and minute (min) drop down boxes and select an end time using the second set of hour and minute (min) drop down boxes. If you have chosen On earlier for the WLAN Status the Wireless LAN will turn on between the two times you enter in these fields. If you have chosen Off earlier for the WLAN Status the Wireless LAN will turn off between the two times you enter in these fields.
Apply	Click Apply to save your changes back to the PLA4231.
Cancel	Click Cancel to reload the previous configuration for this screen.

11.1 Overview

This chapter describes how to configure LAN settings.

A Local Area Network (LAN) is a shared communication system to which many computers are attached. A LAN is a computer network limited to the immediate area, usually the same building or floor of a building. The LAN screens can help you configure the manage IP address, and partition your physical network into logical networks.

Figure 55 LAN Example

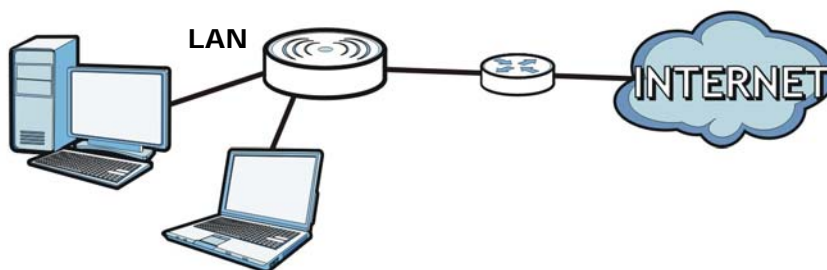

The LAN screens can help you manage IP addresses.

11.2 What You Can Do

- Use the **IP** screen ([Section 11.4 on page 80](#)) to change the IP address for your PLA4231 and DNS server information.
- Use the **IP Alias** screen ([Section 11.5 on page 81](#)) to have the PLA4231 apply IP alias to create LAN subnets.

11.3 What You Need To Know

There are two separate IP networks, one inside the LAN network and the other outside the WAN network as shown next.

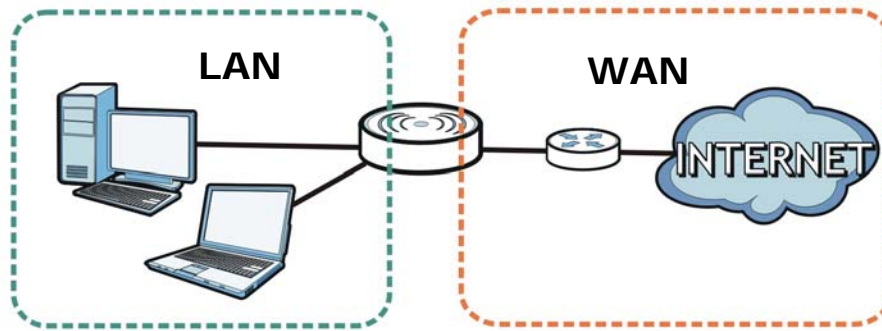
Figure 56 LAN and WAN IP Addresses

The LAN parameters of the PLA4231 are preset in the factory with the following values:

- IP address of 192.168.1.2 with subnet mask of 255.255.255.0 (24 bits)

11.3.1 LAN TCP/IP

The PLA4231 has built-in DHCP server capability that assigns IP addresses and DNS servers to systems that support DHCP client capability.

11.3.2 IP Alias

IP alias allows you to partition a physical network into different logical networks over the same Ethernet interface. The PLA4231 supports three logical LAN interfaces via its single physical Ethernet interface with the PLA4231 itself as the gateway for each LAN network.

11.4 LAN IP Screen

Use this screen to change the IP address for your PLA4231. Click **Network > LAN > IP**.

Figure 57 Network > LAN > IP (Access Point or Universal Repeater)

The following table describes the labels in this screen.

Table 28 Network > LAN > IP

LABEL	DESCRIPTION
Obtain an IP Address Automatically	<p>Click this to deploy the PLA4231 as a DHCP client in the network.</p> <p>When you enable this, the PLA4231 gets its IP address from the network's DHCP server (for example, your ISP or router). Users connected to the PLA4231 can now access the network (i.e., the Internet if the IP address is given by the ISP or a router with Internet access).</p> <p>The Web Configurator may no longer be accessible unless you know the IP address assigned by the DHCP server to the PLA4231. Otherwise, you need to reset the PLA4231 to be able to access the Web Configurator again (see Section 13.7 on page 92 for details on how to reset the PLA4231).</p> <p>Also when you select this, you cannot enter an IP address for your PLA4231 in the field below.</p>
Static IP Address	Click this if you want to specify the IP address of your PLA4231. Or if your ISP or network administrator gave you a static IP address to access the network or the Internet.
IP Address	Type the IP address in dotted decimal notation. The default setting is 192.168.1.2. If you change the IP address you will have to log in again with the new IP address.
Subnet Mask	The subnet mask specifies the network number portion of an IP address.
Gateway IP Address	Enter a gateway IP address (if your ISP or network administrator gave you one) in this field.
DNS Server	
First DNS Server Second DNS Server	<p>Select Obtained From ISP if your ISP or router to which the PLA4231 connects dynamically assigns DNS server information (and the PLA4231's WAN IP address). The field to the right displays the (read-only) DNS server IP address that the ISP assigns.</p> <p>Select User-Defined if you have the IP address of a DNS server. Enter the DNS server's IP address in the field to the right.</p> <p>Select None if you do not want to configure DNS servers. If you do not configure a DNS server, you must know the IP address of a computer in order to access it.</p>
Apply	Click Apply to save your changes back to the PLA4231.
Cancel	Click Cancel to reload the previous configuration for this screen.

11.5 IP Alias Screen

Use this screen to have the PLA4231 apply IP alias to create LAN subnets. Click **LAN > IP Alias**.

Figure 58 Network > LAN > IP Alias

The following table describes the labels in this screen.

Table 29 Network > LAN > IP Alias

LABEL	DESCRIPTION
IP Alias	Check this to enable IP alias.
IP Address	Type the IP alias address of your PLA4231 in dotted decimal notation.
IP Subnet Mask	The subnet mask specifies the network number portion of an IP address.
Apply	Click Apply to save your changes back to the PLA4231.
Cancel	Click Cancel to reload the previous configuration for this screen.

HomePlug

12.1 Overview

This chapter describes how to configure powerline settings. See [Chapter 5 on page 27](#) for more information about powerline network security.

12.2 What You Can Do

Use the **HomePlug** screen ([Section 12.3 on page 83](#)) to secure, manage and set up Quality of Service (QoS) on your powerline network.

12.3 HomePlug Screen

Use this screen to change the powerline settings for your PLA4231. Click **Network > HomePlug**.

Figure 59 Network > HomePlug

The screenshot shows the 'Powerline Setting' configuration page. It includes fields for Network Name, Network Topology, Refresh Interval, a table for Site and MAC Address, a DAK Password field, and a section for Network Name (NMK) with radio buttons for device-specific or all-devices settings. A 'Network Information' section at the bottom shows the Central Coordinator MAC and a table for Site, MAC Address, Transmit Rate, and Receive Rate.

Site	MAC Address	DAK Password
<input type="radio"/> Local	00:12:0E:11:13:1A	

Network Name(NMK):

Set NMK to this device
 Set NMK to all devices

Site	MAC Address	Transmit Rate(Mbps)	Receive Rate(Mbps)
	00:12:0E:11:13:1A		

The following table describes the labels in this screen.

Table 30 Configuration Screen

LABEL	DESCRIPTION
Network	
Refresh Interval	Select a number of seconds or None from the drop-down list box to update the powerline network information automatically at the end of every time interval or to not refresh the powerline network information.
The fields described below are used to identify the powerline adapters recognized on the powerline network. Click Scan to refresh the information in these fields (immediately).	
Note: Only devices which share the same network name are displayed in this table.	
Site	This field displays <ul style="list-style-type: none"> • Local, if it is identifying the powerline adapter directly connected to the computer running the Web Configurator. • Remote, if it is a powerline adapter in your powerline network but not directly connected to the computer running the Web Configurator.
MAC Address	This is a read-only field which shows the MAC address of the powerline adapter you are configuring. You can find the MAC address of your PLA4231 displayed on a sticker on the bottom of your device.
DAK Password	DAK (Device Access Key) password is used to verify that you are authorized to perform changes on a remote device. You can find the DAK password printed on a sticker on the bottom of your PLA4231. Select the remote powerline adapter you want to manage by clicking the MAC address which corresponds to it in the MAC Address column. Enter the DAK Password value and click Save . Note: You must enter the DAK Password value exactly as it is printed on the label (all caps and with dashes "-").
Network Name (NMK)	The default network name (sometimes called a network password or network membership key (NMK)) of the PLA4231 is " HomePlugAV ". HomePlug compatible devices use the same network name to recognize and communicate with each other over the powerline network. If you change the network name of one device on the network, it will no longer be recognized as part of that network. If you change the network name, make sure you change the network name for all of the powerline adapters that you want to be part of your powerline network. The network name can be from 8 to 64 characters in length, using "A"~"Z", "a"~"z", "0"~"9"; spaces are not allowed.
Set NMK to this device	Select this to apply the NMK (entered in the field above) as the network name for the powerline adapter directly connected to the computer running the Web Configurator.
Set NMK to all devices	Select this to apply the NMK (entered in the field above) as the network name for all powerline adapter detected by the Web Configurator.
Write	Click this to apply your changes. The new Network Name is applied to the selected powerline adapter. Note: You must enter the correct DAK password for the selected powerline adapter before you can make changes to it.
Network Information	

Table 30 Configuration Screen (continued)

LABEL	DESCRIPTION
Central Coordinator MAC	The Central Coordinator of the powerline network is the powerline adapter which keeps track of which devices are part of the network as well as synchronizes communication within the powerline network. If the Central Coordinator is removed from the powerline network then another powerline adapter takes its place. This field displays the MAC address of the PLA4231 which is the Central Coordinator of the powerline network. The powerline adapters in your powerline network automatically select the Central Coordinator.
<p>The information provided in the following table reflects transmission rate information about the powerline adapters which communicate in your powerline network.</p> <p>The powerline adapters listed in this table are all the powerline adapters in your powerline network except the powerline adapter selected in the table of the Network Name section. In other words, if the Local powerline adapter is selected in the table of the Network Name section, then this table will display the rates of transmission from the powerline adapter connected to the computer running the Web Configurator to all the Remote powerline adapters.</p>	
Site	<p>This field displays:</p> <ul style="list-style-type: none"> • Local, if it is the PLA4231 directly connected to the computer running the Web Configurator. • Remote, if it is a PLA4231 in your powerline network but not directly connected to the computer running the Web Configurator.
MAC Address	This field displays the MAC address of your powerline adapter. The MAC address of your powerline adapter can be found by looking at the label on your device. It consists of six pairs of hexadecimal characters (hexadecimal characters are "0-9" and "a-f"). In the case of the PLA4231, this label is on the bottom of the device.
Transmit Rate (Mbps)	This field displays how fast information is sent from the powerline adapter selected in the table of the Network Name section to this powerline adapter. The rate is given in the following format: "application data transmission rate / raw data transmission rate". Application data reflects more accurately how fast devices are transmitting application relevant traffic (for example Internet Protocol (IP) traffic). Raw data refers to the whole payload of the packets transmitted across the powerline network.
Receive Rate (Mbps)	This field displays how fast information is received from the powerline adapter selected in the table of the Network Name section to this powerline adapter. The rate is given in the following format: "application data transmission rate / raw data transmission rate". Application data reflects more accurately how fast devices are transmitting application relevant traffic (for example Internet Protocol (IP) traffic). Raw data refers to the whole payload of the packets transmitted across the powerline network.

Maintenance

13.1 Overview

This chapter provides information on the **Maintenance** screens.

13.2 What You Can Do

- Use the **General** screen ([Section 13.3 on page 87](#)) to set the timeout period of the management session.
- Use the **Password** screen ([Section 13.4 on page 88](#)) to change your PLA4231's system password.
- Use the **Time** screen ([Section 13.5 on page 88](#)) to change your PLA4231's time and date.
- Use the **Firmware Upgrade** screen ([Section 13.6 on page 90](#)) to upload firmware to your PLA4231.
- Use the **Backup/Restore** screen ([Section 13.8 on page 93](#)) to view information related to factory defaults, backup configuration, and restoring configuration.
- Use the **Restart** screen ([Section 13.8 on page 93](#)) to reboot the PLA4231 without turning the power off.
- Use the **Language** screen ([Section 13.9 on page 93](#)) to change the language for the Web Configurator.

13.3 General Screen

Use this screen to set the management session timeout period. Click **Maintenance > General**. The following screen displays.

Figure 60 Maintenance > General

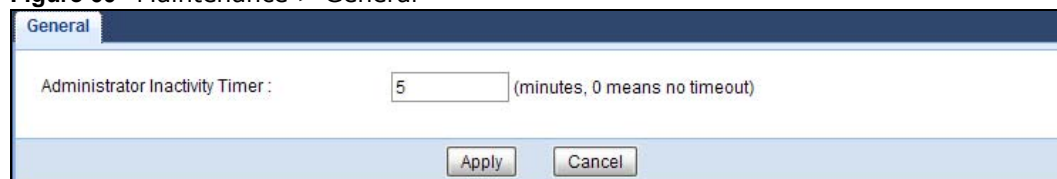

The screenshot shows a web interface for the 'General' maintenance screen. At the top, there is a dark blue header with the word 'General' in white. Below the header, the main content area is white. It features a label 'Administrator Inactivity Timer:' followed by a text input field containing the number '5'. To the right of the input field is the text '(minutes, 0 means no timeout)'. At the bottom of the form, there are two buttons: 'Apply' and 'Cancel'.

The following table describes the labels in this screen.

Table 31 Maintenance > General

LABEL	DESCRIPTION
Administrator Inactivity Timer	Type how many minutes a management session can be left idle before the session times out. The default is 5 minutes. After it times out you have to log in with your password again. Very long idle timeouts may have security risks. A value of "0" means a management session never times out, no matter how long it has been left idle (not recommended).
Apply	Click Apply to save your changes back to the PLA4231.
Cancel	Click Cancel to reload the previous configuration for this screen.

13.4 Password Screen

It is strongly recommended that you change your PLA4231's password.

If you forget your PLA4231's password (or IP address), you will need to reset the device. See [Section 13.8 on page 93](#) for details

Click **Maintenance > Password**.

Figure 61 Maintenance > Password

The following table describes the labels in this screen.

Table 32 Maintenance > Password

LABEL	DESCRIPTION
Old Password	Type the default password or the existing password you use to access the system in this field.
New Password	Type your new system password (up to 30 characters). Note that as you type a password, the screen displays an asterisk (*) for each character you type.
Retype to Confirm	Type the new password again in this field.
Apply	Click Apply to save your changes back to the PLA4231.
Cancel	Click Cancel to reload the previous configuration for this screen.

13.5 Time Setting Screen

Use this screen to configure the PLA4231's time based on your local time zone. To change your PLA4231's time and date, click **Maintenance > Time**. The screen appears as shown.

Figure 62 Maintenance > Time

the following table describes the labels in this screen.

Table 33 Maintenance > Time

LABEL	DESCRIPTION
Current Time and Date	
Current Time	This field displays the time of your PLA4231. Each time you reload this page, the PLA4231 synchronizes the time with the time server.
Current Date	This field displays the date of your PLA4231. Each time you reload this page, the PLA4231 synchronizes the date with the time server.
Time and Date Setup	
Manual	Select this radio button to enter the time and date manually. If you configure a new time and date, Time Zone and Daylight Saving at the same time, the new time and date you entered has priority and the Time Zone and Daylight Saving settings do not affect it.
New Time (hh:mm:ss)	This field displays the last updated time from the time server or the last time configured manually. When you select Manual , enter the new time in this field and then click Apply .
New Date (yyyy/mm/dd)	This field displays the last updated date from the time server or the last date configured manually. When you select Manual , enter the new date in this field and then click Apply .
Get from Time Server	Select this radio button to have the PLA4231 get the time and date from the time server you specified below.
User Defined Time Server Address	Enter the IP address or URL (up to 20 extended ASCII characters in length) of your time server. Check with your ISP/network administrator if you are unsure of this information.

Table 33 Maintenance > Time

LABEL	DESCRIPTION
Time Zone Setup	
Time Zone	Choose the time zone of your location. This will set the time difference between your time zone and Greenwich Mean Time (GMT).
Daylight Savings	Daylight saving is a period from late spring to fall when many countries set their clocks ahead of normal local time by one hour to give more daytime light in the evening. Select this option if you use Daylight Saving Time.
Start Date	Configure the day and time when Daylight Saving Time starts if you selected Daylight Savings . The o'clock field uses the 24 hour format. Here are a couple of examples: Daylight Saving Time starts in most parts of the United States on the second Sunday of March. Each time zone in the United States starts using Daylight Saving Time at 2 A.M. local time. So in the United States you would select Second, Sunday, March and type 2 in the o'clock field. Daylight Saving Time starts in the European Union on the last Sunday of March. All of the time zones in the European Union start using Daylight Saving Time at the same moment (1 A.M. GMT or UTC). So in the European Union you would select Last, Sunday, March . The time you type in the o'clock field depends on your time zone. In Germany for instance, you would type 2 because Germany's time zone is one hour ahead of GMT or UTC (GMT+1).
End Date	Configure the day and time when Daylight Saving Time ends if you selected Daylight Savings . The o'clock field uses the 24 hour format. Here are a couple of examples: Daylight Saving Time ends in the United States on the first Sunday of November. Each time zone in the United States stops using Daylight Saving Time at 2 A.M. local time. So in the United States you would select First, Sunday, November and type 2 in the o'clock field. Daylight Saving Time ends in the European Union on the last Sunday of October. All of the time zones in the European Union stop using Daylight Saving Time at the same moment (1 A.M. GMT or UTC). So in the European Union you would select Last, Sunday, October . The time you type in the o'clock field depends on your time zone. In Germany for instance, you would type 2 because Germany's time zone is one hour ahead of GMT or UTC (GMT+1).
Apply	Click Apply to save your changes back to the PLA4231.
Cancel	Click Cancel to reload the previous configuration for this screen.

13.6 Firmware Upgrade Screen

Find firmware at www.zyxel.com in a file that (usually) uses the system model name with a "*.bin" extension, e.g., "PLA4231.bin". The upload process uses HTTP (Hypertext Transfer Protocol) and may take up to two minutes. After a successful upload, the system will reboot.

Click **Maintenance > Firmware Upgrade**. Follow the instructions in this screen to upload firmware to your PLA4231.

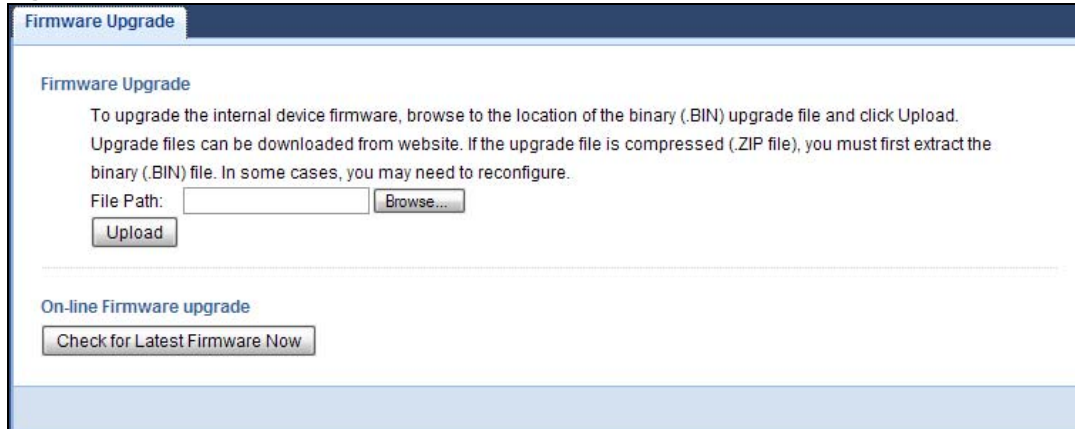
Figure 63 Maintenance > Firmware Upgrade

The following table describes the labels in this screen.

Table 34 Maintenance > Firmware Upgrade

LABEL	DESCRIPTION
Firmware Upgrade	
File Path	Type in the location of the file you want to upload in this field or click Browse... to find it.
Browse...	Click Browse... to find the .bin file you want to upload. Remember that you must decompress compressed (.zip) files before you can upload them.
Upload	Click Upload to begin the upload process. This process may take up to two minutes.
On-line Firmware Upgrade	
Check for Latest Firmware Now	Click this button to get the latest firmware information, such as the version number, release date, release note and file size from the ZyXEL website. Make sure your PLA4231 has Internet access.
Do-Firmware_Upgrade	Click this button to download and install the latest firmware in your PLA4231.

Note: Do not turn off the PLA4231 while firmware upload is in progress!

After you click **Upload**, wait two minutes before logging into the PLA4231 again.

The PLA4231 automatically restarts in this time causing a temporary network disconnect. In some operating systems, you may see the following icon on your desktop.

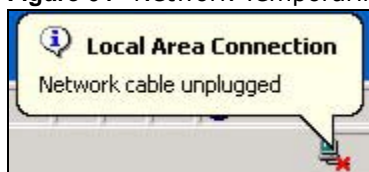
Figure 64 Network Temporarily Disconnected

After two minutes, log in again and check your new firmware version in the **Dashboard** screen.

13.7 Configuration Backup/Restore Screen

Backup configuration allows you to back up (save) the PLA4231's current configuration to a file on your computer. Once your PLA4231 is configured and functioning properly, it is highly recommended that you back up your configuration file before making configuration changes. The backup configuration file will be useful in case you need to return to your previous settings.

Restore configuration allows you to upload a new or previously saved configuration file from your computer to your PLA4231.

Click **Maintenance > Backup/Restore**. Information related to factory defaults, backup configuration, and restoring configuration appears as shown next.

Figure 65 Maintenance > Backup/Restore

The screenshot shows a web interface for the PLA4231. At the top, there is a tab labeled 'Backup/Restore'. Below this, the page is divided into three sections:

- Backup Configuration:** A heading followed by the instruction 'Click Backup to save the current configuration of your system to your computer.' and a 'Backup' button.
- Restore Configuration:** A heading followed by the instruction 'To restore a previously saved configuration file to your system, browse to the location of the configuration file and click Upload.' Below this is a 'File Path' input field, a 'Browse...' button, and an 'Upload' button.
- Back to Factory Defaults:** A heading followed by the instruction 'Click Reset to clear all user-entered configuration information and return to factory defaults. After resetting, the' and two bullet points: '- Password will be 1234' and '- LAN IP address will be 192.168.1.2'. Below this is a 'Reset' button.

The following table describes the labels in this screen.

Table 35 Maintenance > Backup/Restore

LABEL	DESCRIPTION
Backup	Click Backup to save the PLA4231's current configuration to your computer.
File Path	Type in the location of the file you want to upload in this field or click Browse... to find it.
Browse...	Click Browse... to find the file you want to upload. Remember that you must decompress compressed (.ZIP) files before you can upload them.
Upload	Click Upload to begin the upload process. Note: Do not turn off the PLA4231 while configuration file upload is in progress. After you click Upload , you must then wait one minute before logging into the PLA4231 again. The PLA4231 automatically restarts in this time causing a temporary network disconnect.
Reset	Pressing the Reset button in this section clears all user-entered configuration information and returns the PLA4231 to its factory defaults. You can also press the RESET button on the rear panel to reset the factory defaults of your PLA4231. Refer to the chapter about introducing the Web Configurator for more information on the RESET button.

Note: If you uploaded the default configuration file you may need to change the IP address of your computer to be in the same subnet as that of the default PLA4231 IP address (192.168.1.2).

13.8 Restart Screen

System restart allows you to reboot the PLA4231 without turning the power off.

Click **Maintenance > Restart** to open the following screen.

Figure 66 Maintenance > Restart

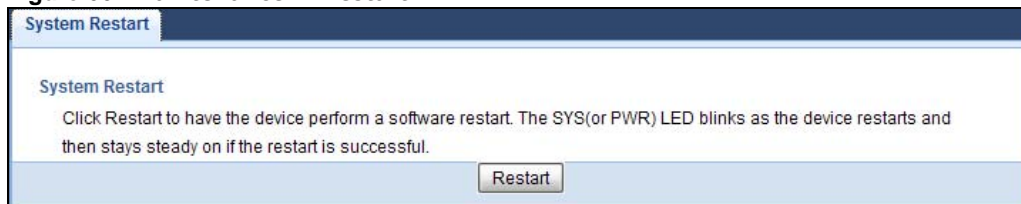

Click **Restart** to have the PLA4231 reboot. This does not affect the PLA4231's configuration.

13.9 Language Screen

Use this screen to change the language for the Web Configurator.

Select the language you prefer and click **Apply**. The Web Configurator language changes after a while without restarting the PLA4231.

Figure 67 Maintenance > Language

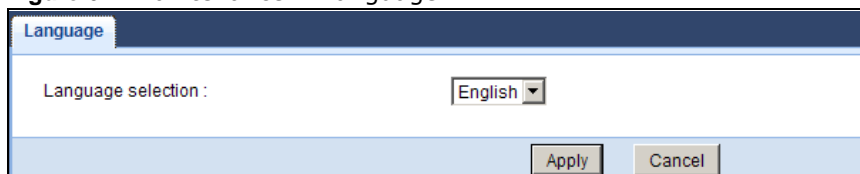

LEDs and Troubleshooting

This chapter describes the behavior of the LEDs (lights) and offers some suggestions to solve problems you might encounter.

14.1 LEDs

The following sections describes the lights on the PLA4231.



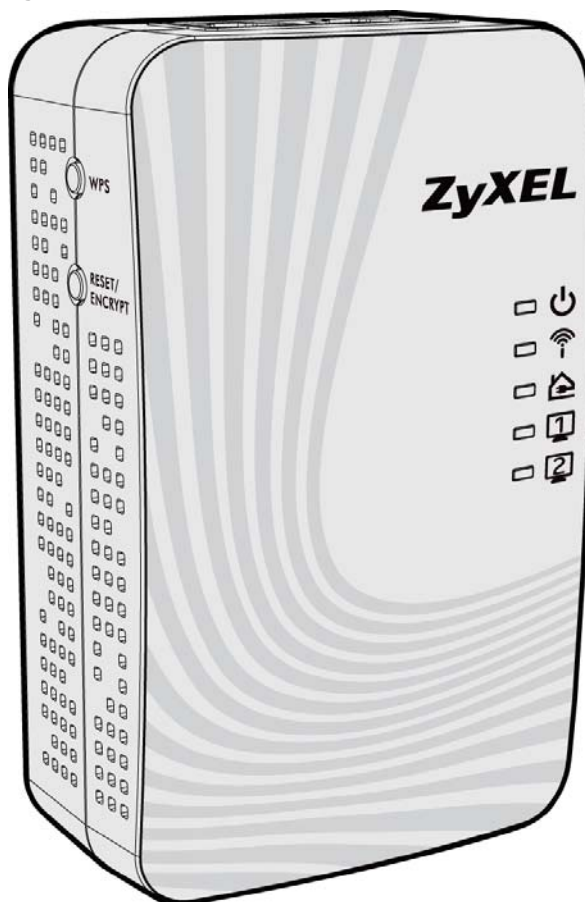

The following figure is the front panel of the PLA4231. Use the lights to determine if the PLA4231 is behaving normally or if there are some problems on your powerline network.

Figure 68 PLA4231 Lights



The following table describes the behavior of the lights on the PLA4231.

Table 36 PLA4231

LIGHTS	ICON	COLOR	STATUS	DESCRIPTION
POWER		Green	On	The PLA4231 is on and receiving power. It also indicates a successful connection using the RESET/ENCRYPT button.
			Blinking	The PLA4231 is starting up. It also indicates the PLA4231 is trying to connect with another device using the ENCRYPT function. Blinking at the same time as the HomePlug light indicates an unsuccessful connection if you have used the RESET/ENCRYPT button.
			Off	The PLA4231 is not receiving power.
WLAN		Green	On	The PLA4231's wireless LAN is ready, or WPS is enabled.
			Fast Blinking	The PLA4231 is sending/receiving data through the wireless LAN, or WPS has failed.
			Slow Blinking	The PLA4231 is negotiating a WPS connection with a wireless device.
			Off	The wireless LAN is not ready or has failed.
HomePlug		Green	On	The PLA4231 detects another powerline adapter. The data transfer rate is greater than 80 Mbps.
		Amber		The PLA4231 detects another powerline adapter. The data transfer rate is between 20~80 Mbps.
		Red		The PLA4231 detects another powerline adapter. The data transfer rate is between 0~20 Mbps.
		Green/ Amber/ Red	Blinking	The PLA4231 is communicating with another powerline adapter. Data is being transmitted and/or received. Blinking at the same time as the POWER light indicates an unsuccessful connection if you have used the RESET/ENCRYPT button.
			Off	The HomePlug port does not detect another powerline adapter.
Ethernet 1/ 2		Green	On	The PLA4231 has a successful 10/100MB Ethernet connection.
			Blinking	The PLA4231 is communicating with a networking device connected to the Ethernet port.
			Off	The PLA4231 does not detect any devices connected to its Ethernet port.

14.2 Power and Light Problems

The PLA4231 does not turn on. None of the lights turn on.

- 1 Make sure the PLA4231 is plugged in to an appropriate power source.

- 2 Make sure the power button at the side of the PLA4231 is pushed in.
- 3 Remove the powerline adapter from the outlet. Then connect an electrical device that you know works into the same power outlet. This checks the status of the power outlet.
- 4 If the problem continues, contact the vendor.

The Ethernet light does not turn on.

- 1 Check the hardware connections. See the Quick Start Guide.
- 2 Inspect your cables for damage. Contact the vendor to replace any damaged cables.
- 3 Check the Ethernet adapter on your computer and make sure it's enabled and working properly.
- 4 If the PLA4231 is connected to an Ethernet switch or router, make sure the device is working correctly, and that the LAN network is working and configured correctly as well.

The HomePlug light does not turn on.

- 1 Check all PLA4231s on your network have the latest firmware installed. PLA4231s with the latest firmware cannot communicate with PLA4231s using earlier versions of the firmware. Go to [Section 5.4 on page 30](#) or [Section 13.6 on page 90](#) for instructions on installing the latest firmware.
- 2 Use the **PLA42xx Series Configuration Utility** to detect all other HomePlug devices on your powerline network. Make sure that the network name (sometimes called the network password) is the same on all of your powerline adapters. See [Section 5.3 on page 29](#) or [Section 12.3 on page 83](#) for instructions on checking the network name.
- 3 Check the DAK password and MAC address for all powerline adapters are typed correctly in the utility. See [Section 5.3 on page 29](#) or [Section 12.3 on page 83](#) for instructions on checking the DAK and MAC address.
- 4 Make sure that all your powerline adapters are HomePlug AV compliant. Check the package it came in or ask your vendor. This PLA4231 can not detect earlier versions of HomePlug powerline adapters such as HomePlug 1.0 or 1.0.1. (Although they can coexist on the same electrical wiring without interfering with each other.)
- 5 Make sure that the powerline adapters on your network are all on the same electrical wiring. Connect another powerline adapter into an outlet close to your PLA4231's power outlet. They are probably now on the same electrical wiring. Check the HomePlug  light. If it now lights up your powerline adapter was probably previously on separate electrical wiring. Ask an electrician for more information on the electrical wiring in your building.
- 6 If your powerline network is using coaxial cable, check all powerline adapters are on the same coaxial cable.

- 7 If your powerline network is using electrical wiring (not coaxial cable), check you do not have a power meter between powerline adapters. Powerline signals cannot pass this.

The **POWER** and **HomePlug** light blink at the same time.

- You have pressed the **RESET/ENCRYPT** button for more than three seconds. Try setting up a connection again, this time pressing the **RESET/ENCRYPT** buttons on both devices for less than three seconds.

14.3 Configuration Utility Problems

The **PLA42xx Series Configuration Utility** displays an error during installation.

- Make sure your computer is using Windows XP or Windows Vista (32-bit) operating system. At the time of writing, this is the only compatible operating system for the configuration utility.

The **PLA42xx Series Configuration Utility** does not display all or any of my devices.

- Inspect the LEDs on your PLA4231 and make sure that the **ETHERNET** and **HomePlug** LEDs are on or blinking. See [Section 14.1 on page 95](#) for troubleshooting LED related problems.
- Check all ZyXEL HomePlug AV devices on your network have the latest firmware installed. The latest utility cannot communicate with PLA4231s using earlier versions of the firmware. Go to [Section 5.4 on page 30](#) or [Section 13.6 on page 90](#) for instructions on installing the latest firmware.
- Check you are using the latest version utility. Earlier version utilities cannot communicate with PLA4231s using the latest firmware. If you do not have the latest utility, download it from the ZyXEL website.
- If the device is not a ZyXEL device, then the DAK and Network Name will be greyed out.
- If you are running another tool such as the **Firmware Detection Tool**, the Utility will not detect your local device.

14.4 Powerline Problems

The signal on my powerline network is weak.

- 1 Your powerline adapters may be connected to electrical surge protectors. Connect them to standard power outlets.

- 2 Your powerline adapters may be located close to large appliances such as refrigerators or air-conditioners that cause interference with the powerline signal. Move the adapters further away from such appliances to reduce interference.
- 3 Your powerline adapters may be placed close to electrical devices such as electrical insect-killers which produce radio waves. These may interfere with the powerline signals. Move the adapters further away from such electrical devices.
- 4 Your wiring may be old and/or low quality or with a long wiring path.

14.5 RESET/ENCRYPT Button Problems

This section applies only to PLA4231s with the **RESET/ENCRYPT** button.

The HomePlug light is already on, but I haven't pressed the **RESET/ENCRYPT** button yet.

Your device has already connected to another powerline device. Press the **RESET/ENCRYPT** button for 5 to 8 seconds to release the connection.

The **POWER** light does not blink when I press the **RESET/ENCRYPT** button.

- Check the device is on.
- Press the **RESET/ENCRYPT** button again, making certain you have pressed the button for 0.5 to 3 seconds.
- The **POWER** light on some powerline devices do not blink as part of the **ENCRYPT** process. Check your powerline device is a PLA4231.
- For PLA4231, you cannot use the **RESET/ENCRYPT** button when it is in Low Power mode. Connect the PLA4231 to a computer/router then try again.

The **POWER** light blinks two times quickly then pauses, before repeating.

The **ENCRYPT** process has failed. Press the **RESET/ENCRYPT** button on both devices for 5 to 8 seconds, then try to reconnect.

The **POWER** lights on both devices blink when I press the **RESET/ENCRYPT** buttons, but the HomePlug light does not turn on.

- Ensure you have pressed the **RESET/ENCRYPT** button on both devices.
- Wait for about a minute while the devices set up a connection.

- If that does not work, try again with both devices connected to a power strip next to each other. If they now connect, then the devices were not on the same electrical circuit before.

The POWER lights on both devices blink, then many lights blink and the HomePlug light blinks red.

Do not worry, the connection process is proceeding normally.

The POWER lights on both devices finished blinking, but only one device's HomePlug light is on.

One device may have connected to a third powerline device. To check device A is connected to device B and not another device, disconnect device B from its power source. Device A's HomePlug (🏠) light will turn off if the connection is with Device B. Press the **RESET/ENCRYPT** button on both devices for 5 to 8 seconds, then try to reconnect, pressing the **RESET/ENCRYPT** button for 0.5 to 3 seconds on both devices.

I pressed the RESET/ENCRYPT button for 5 to 8 seconds, but the HomePlug light is still on.

The HomePlug light is on, indicating it is still connected to another powerline device. Try again, pressing the **RESET/ENCRYPT** button for 5 to 8 seconds.

14.6 Wireless Connection Problems

I cannot access the PLA4231 or ping any computer from the WLAN.

- 1 Make sure the wireless LAN is enabled on the PLA4231.
- 2 Make sure the wireless adapter installed on your computer is working properly.
- 3 Make sure the wireless adapter installed on your computer is IEEE 802.11 compatible and supports the same wireless standard as the PLA4231.
- 4 Make sure your computer (with a wireless adapter installed) is within the transmission range of the PLA4231.
- 5 Check that both the PLA4231 and your computer (with a wireless adapter installed) are using the same wireless and wireless security settings.

What factors may cause intermittent or unstabled wireless connection? How can I solve this problem?

The following factors may cause interference:

- Obstacles: walls, ceilings, furniture, and so on.
- Building Materials: metal doors, aluminum studs.
- Electrical devices: microwaves, monitors, electric motors, cordless phones, and other wireless devices.

To optimize the speed and quality of your wireless connection, you can:

- Move your wireless device closer to the AP if the signal strength is low.
- Reduce wireless interference that may be caused by other wireless networks or surrounding wireless electronics such as cordless phones.
- Place the AP where there are minimum obstacles (such as walls and ceilings) between the AP and the wireless client.
- Reduce the number of wireless clients connecting to the same AP simultaneously, or add additional APs if necessary.
- Try closing some programs that use the Internet, especially peer-to-peer applications. If the wireless client is sending or receiving a lot of information, it may have too many programs open that use the Internet.
- Position the antennas for best reception. If the AP is placed on a table or floor, point the antennas upwards. If the AP is placed at a high position, point the antennas downwards. Try pointing the antennas in different directions and check which provides the strongest signal to the wireless clients.

14.7 PLA4231 Access and Login Problems

I don't know the IP address of my PLA4231.

- 1 The default IP address is **192.168.1.2**.
- 2 If you changed the IP address and have forgotten it,
 - and your PLA4231 is a DHCP client, you can find your IP address from the DHCP server. This information is only available from the DHCP server which allocates IP addresses on your network. Find this information directly from the DHCP server or contact your system administrator for more information.
 - reset your PLA4231 to change all settings back to their default. This means your current settings are lost. See [Section 1.7 on page 12](#) for information on resetting your PLA4231.

I forgot the password.

- 1 The default password is **1234**.
- 2 If this does not work, you have to reset the device to its factory defaults. See [Section 1.7 on page 12](#).

I cannot see or access the **Login** screen in the Web Configurator.

- 1 Make sure you are using the correct IP address.
 - The default IP address is [192.168.1.2](#).
 - If you changed the IP address ([Section 11.4 on page 80](#)), use the new IP address.
 - If you changed the IP address and have forgotten it, see the troubleshooting suggestions for [I don't know the IP address of my PLA4231](#).
- 2 Check the hardware connections, and make sure the LEDs are behaving as expected. See the Quick Start Guide.
- 3 Make sure your Internet browser does not block pop-up windows and has JavaScripts and Java enabled. See [Appendix A on page 105](#).
- 4 Make sure your computer is in the same subnet as the PLA4231. (If you know that there are routers between your computer and the PLA4231, skip this step.)
 - If there is a DHCP server on your network, make sure your computer is using a dynamic IP address. See [Section 11.4 on page 102](#).
 - If there is no DHCP server on your network, make sure your computer's IP address is in the same subnet as the PLA4231.
- 5 Reset the device to its factory defaults, and try to access the PLA4231 with the default IP address.
- 6 If the problem continues, contact the network administrator or vendor, or try one of the advanced suggestions.

Advanced Suggestion

- If your computer is connected wirelessly, use a computer that is connected to a LAN/Ethernet port.

I can see the **Login** screen, but I cannot log in to the PLA4231.

- 1 Make sure you have entered the password correctly. The default password is **1234**. This field is case-sensitive, so make sure [Caps Lock] is not on.

- 2 This can happen when you fail to log out properly from your last session. Try logging in again after 5 minutes.
- 3 Disconnect and re-connect the power adaptor or cord to the PLA4231.
- 4 If this does not work, you have to reset the device to its factory defaults. See [Section 1.7 on page 12](#).

Pop-up Windows, JavaScript and Java Permissions

In order to use the web configurator you need to allow:

- Web browser pop-up windows from your device.
- JavaScript (enabled by default).
- Java permissions (enabled by default).

Note: The screens used below belong to Internet Explorer version 6, 7 and 8. Screens for other Internet Explorer versions may vary.

Internet Explorer Pop-up Blockers

You may have to disable pop-up blocking to log into your device.

Either disable pop-up blocking (enabled by default in Windows XP SP (Service Pack) 2) or allow pop-up blocking and create an exception for your device's IP address.

Disable Pop-up Blockers

- 1 In Internet Explorer, select **Tools, Pop-up Blocker** and then select **Turn Off Pop-up Blocker**.

Figure 69 Pop-up Blocker

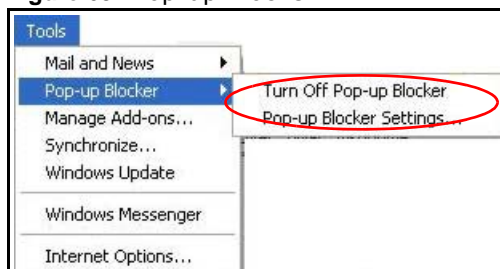

You can also check if pop-up blocking is disabled in the **Pop-up Blocker** section in the **Privacy** tab.

- 1 In Internet Explorer, select **Tools, Internet Options, Privacy**.
- 2 Clear the **Block pop-ups** check box in the **Pop-up Blocker** section of the screen. This disables any web pop-up blockers you may have enabled.

Figure 70 Internet Options: Privacy



- 3 Click **Apply** to save this setting.

Enable Pop-up Blockers with Exceptions

Alternatively, if you only want to allow pop-up windows from your device, see the following steps.

- 1 In Internet Explorer, select **Tools, Internet Options** and then the **Privacy** tab.
- 2 Select **Settings...** to open the **Pop-up Blocker Settings** screen.

Figure 71 Internet Options: Privacy

- 3 Type the IP address of your device (the web page that you do not want to have blocked) with the prefix "http://". For example, http://192.168.167.1.
- 4 Click **Add** to move the IP address to the list of **Allowed sites**.

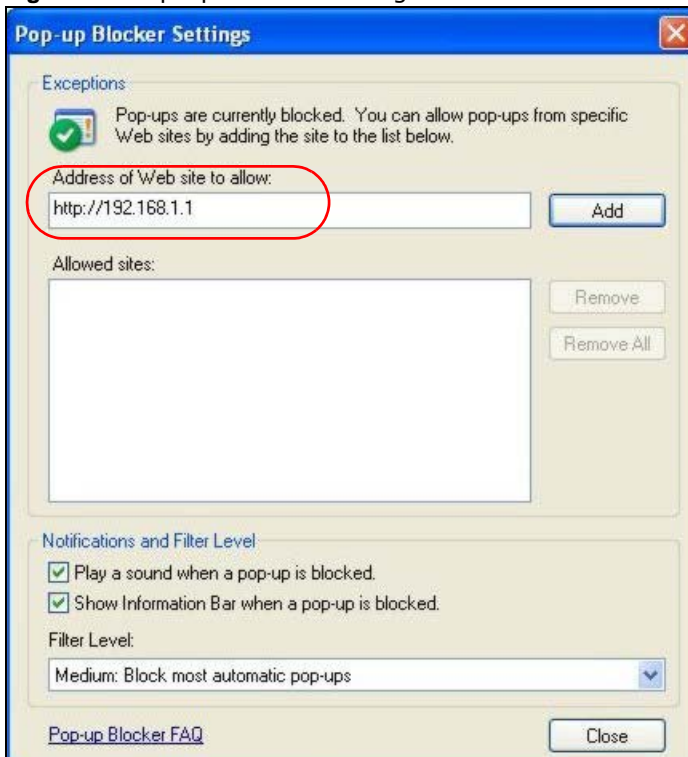
Figure 72 Pop-up Blocker Settings

- 5 Click **Close** to return to the **Privacy** screen.
- 6 Click **Apply** to save this setting.

JavaScript

If pages of the web configurator do not display properly in Internet Explorer, check that JavaScript are allowed.

- 1 In Internet Explorer, click **Tools**, **Internet Options** and then the **Security** tab.

Figure 73 Internet Options: Security

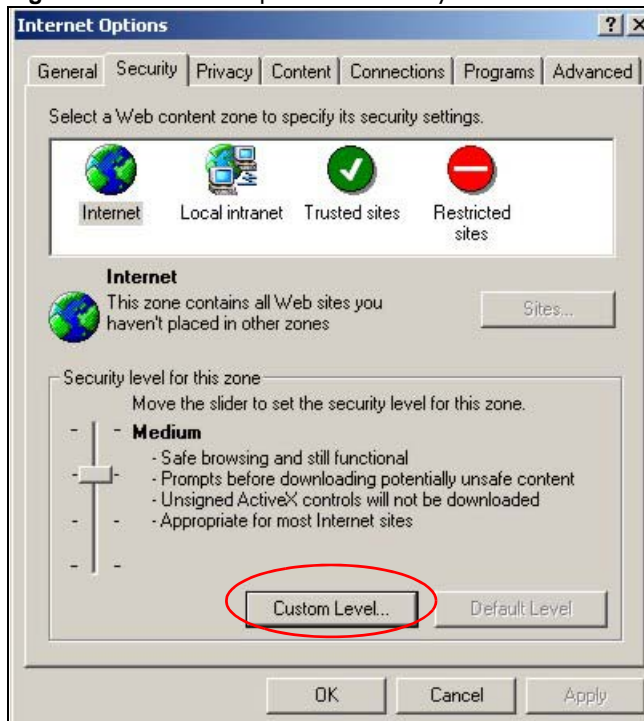

- 2 Click the **Custom Level...** button.
- 3 Scroll down to **Scripting**.
- 4 Under **Active scripting** make sure that **Enable** is selected (the default).
- 5 Under **Scripting of Java applets** make sure that **Enable** is selected (the default).
- 6 Click **OK** to close the window.

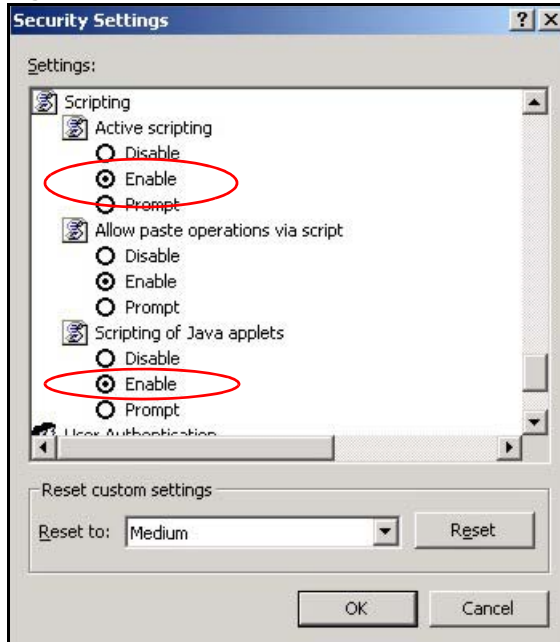
Figure 74 Security Settings - Java Scripting

Java Permissions

- 1 From Internet Explorer, click **Tools, Internet Options** and then the **Security** tab.
- 2 Click the **Custom Level...** button.
- 3 Scroll down to **Microsoft VM**.
- 4 Under **Java permissions** make sure that a safety level is selected.
- 5 Click **OK** to close the window.

Figure 75 Security Settings - Java

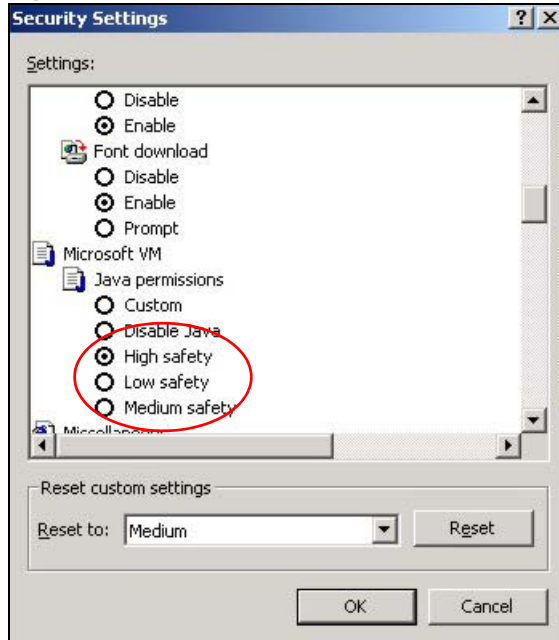

JAVA (Sun)

- 1 From Internet Explorer, click **Tools, Internet Options** and then the **Advanced** tab.
- 2 Make sure that **Use Java 2 for <applet>** under **Java (Sun)** is selected.
- 3 Click **OK** to close the window.

Figure 76 Java (Sun)

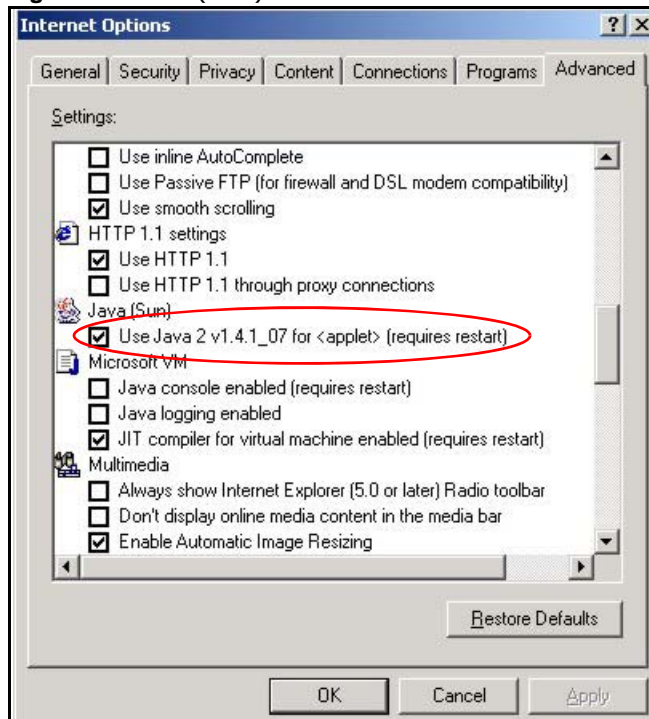

Mozilla Firefox

Mozilla Firefox 2.0 screens are used here. Screens for other versions may vary slightly. The steps below apply to Mozilla Firefox 3.0 as well.

You can enable Java, Javascript and pop-ups in one screen. Click **Tools**, then click **Options** in the screen that appears.

Figure 77 Mozilla Firefox: TOOLS > Options

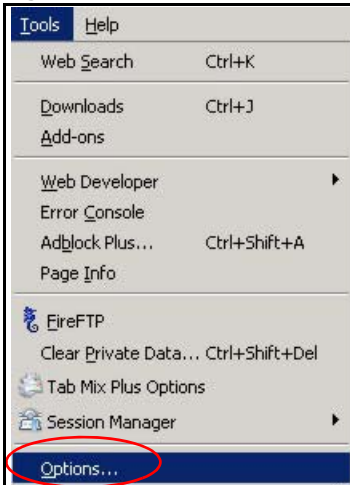

Click **Content** to show the screen below. Select the check boxes as shown in the following screen.

Figure 78 Mozilla Firefox Content Security

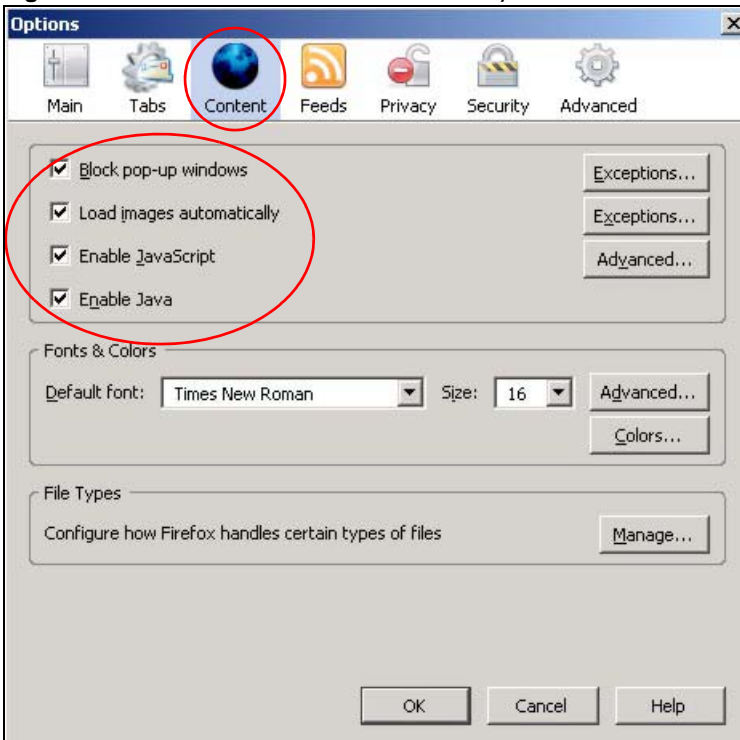

Opera

Opera 10 screens are used here. Screens for other versions may vary slightly.

Allowing Pop-Ups

From Opera, click **Tools**, then **Preferences**. In the **General** tab, go to **Choose how you prefer to handle pop-ups** and select **Open all pop-ups**.

Figure 79 Opera: Allowing Pop-Ups

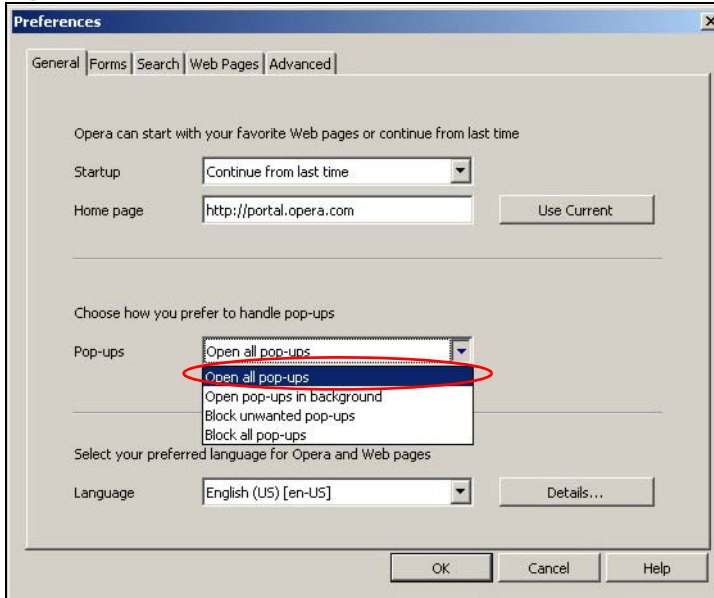

Enabling Java

From Opera, click **Tools**, then **Preferences**. In the **Advanced** tab, select **Content** from the left-side menu. Select the check boxes as shown in the following screen.

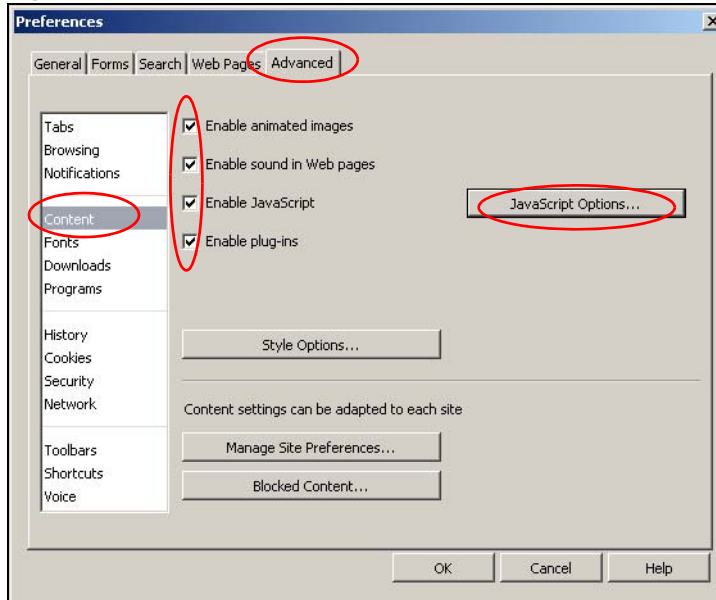
Figure 80 Opera: Enabling Java

To customize JavaScript behavior in the Opera browser, click **JavaScript Options**.

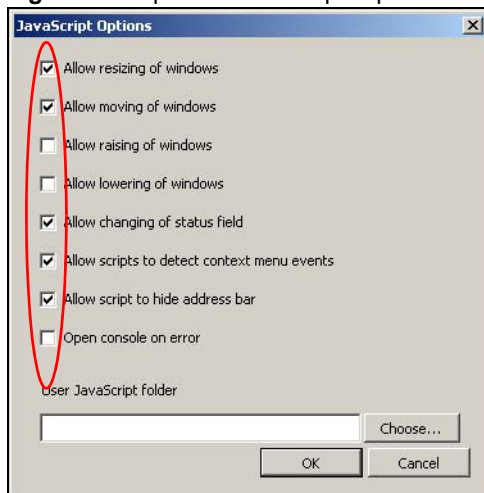
Figure 81 Opera: JavaScript Options

Select the items you want Opera's JavaScript to apply.

Legal Information

Copyright

Copyright © 2012 by ZyXEL Communications Corporation.

The contents of this publication may not be reproduced in any part or as a whole, transcribed, stored in a retrieval system, translated into any language, or transmitted in any form or by any means, electronic, mechanical, magnetic, optical, chemical, photocopying, manual, or otherwise, without the prior written permission of ZyXEL Communications Corporation.

Published by ZyXEL Communications Corporation. All rights reserved.

Disclaimer

ZyXEL does not assume any liability arising out of the application or use of any products, or software described herein. Neither does it convey any license under its patent rights nor the patent rights of others. ZyXEL further reserves the right to make changes in any products described herein without notice. This publication is subject to change without notice.

Trademarks

NetUSB is a trademark of ZyXEL Communications, Inc. Other trademarks mentioned in this publication are used for identification purposes only and may be properties of their respective owners.

Certifications

Federal Communications Commission (FCC) Interference Statement

The device complies with Part 15 of FCC rules. Operation is subject to the following two conditions:

- This device may not cause harmful interference.
- This device must accept any interference received, including interference that may cause undesired operations.

This device has been tested and found to comply with the limits for a Class B digital device pursuant to Part 15 of the FCC Rules. These limits are designed to provide reasonable protection against harmful interference in a residential installation. This device generates, uses, and can radiate radio frequency energy, and if not installed and used in accordance with the instructions, may cause harmful interference to radio communications. However, there is no guarantee that interference will not occur in a particular installation.

If this device does cause harmful interference to radio/television reception, which can be determined by turning the device off and on, the user is encouraged to try to correct the interference by one or more of the following measures:

- 1 Reorient or relocate the receiving antenna.
- 2 Increase the separation between the equipment and the receiver.
- 3 Connect the equipment into an outlet on a circuit different from that to which the receiver is connected.
- 4 Consult the dealer or an experienced radio/TV technician for help.

FCC Caution: Any changes or modifications not expressly approved by the party responsible for compliance could void the user's authority to operate this equipment.



FCC Radiation Exposure Statement

- This transmitter must not be co-located or operating in conjunction with any other antenna or transmitter.
- IEEE 802.11b, 802.11g or 802.11n (20MHz) operation of this product in the U.S.A. is firmware-limited to channels 1 through 11. IEEE 802.11n (40MHz) operation of this product in the U.S.A. is firmware-limited to channels 3 through 9.
- To comply with FCC RF exposure compliance requirements, a separation distance of at least 20 cm must be maintained between the antenna of this device and all persons.

Industry Canada Statement

This device complies with RSS-210 of the Industry Canada Rules. Operation is subject to the following two conditions:

- 1) this device may not cause interference and
- 2) this device must accept any interference, including interference that may cause undesired operation of the device

This device has been designed to operate with an antenna having a maximum gain of 2dBi.

Antenna having a higher gain is strictly prohibited per regulations of Industry Canada. The required antenna impedance is 50 ohms.

To reduce potential radio interference to other users, the antenna type and its gain should be so chosen that the EIRP is not more than required for successful communication.

IC Radiation Exposure Statement

This equipment complies with IC radiation exposure limits set forth for an uncontrolled environment. End users must follow the specific operating instructions for satisfying RF exposure compliance.

注意！

依據 低功率電波輻射性電機管理辦法

第十二條 經型式認證合格之低功率射頻電機，非經許可，公司、商號或使用者均不得擅自變更頻率、加大功率或變更原設計之特性及功能。

第十四條 低功率射頻電機之使用不得影響飛航安全及干擾合法通信；經發現有干擾現象時，應立即停用，並改善至無干擾時方得繼續使用。前項合法通信，指依電信規定作業之無線電信。低功率射頻電機須忍受合法通信或工業、科學及醫療用電波輻射性電機設備之干擾。

CE-Konformität

Das Produkt entspricht den grundlegenden Anforderungen der Richtlinie 1999/5/EG (R&TTE) sowie den übrigen einschlägigen Bestimmungen des FTEG und ist zum Betrieb in der EU und Schweiz vorgesehen. Das Produkt ist eine Einrichtung der Klasse A. Diese Einrichtung kann im Wohnbereich Funkstörungen verursachen; in diesem Fall kann vom Betreiber verlangt werden, angemessene Massnahmen durchzuführen.

Conformité CE

Le produit satisfait aux exigences techniques de la directive 1999/5/CE (R&TTE) et est conçu pour être utilisé au sein de la Communauté européenne et en Suisse. Le produit fait partie de la classe A, ce qui signifie que son exploitation peut entraîner des bruits parasites dans les zones d'habitation; le cas échéant, l'exploitant peut être tenu de prendre des mesures appropriées pour remédier au dérangement.

Conformità CE

Questo prodotto soddisfa le richieste tecniche della direttiva 1999/5/EG (R&TTE) ed è previsto per il funzionamento nella UE e in Svizzera. Il prodotto è dispositivo della classe A. Questo dispositivo può causare nel settore abitativo dei radiodisturbi.

In questo caso può essere richiesto al gestore di prendere opportune misure.

Notices

Changes or modifications not expressly approved by the party responsible for compliance could void the user's authority to operate the equipment.

This device is designed for the WLAN 2.4 GHz and/or 5 GHz networks throughout the EC region and Switzerland, with restrictions in France.

This Class B digital apparatus complies with Canadian ICES-003.

Cet appareil numérique de la classe B est conforme à la norme NMB-003 du Canada.

Viewing Certifications

Go to <http://www.zyxel.com> to view this product's documentation and certifications.

ZyXEL Limited Warranty

ZyXEL warrants to the original end user (purchaser) that this product is free from any defects in material or workmanship for a specific period (the Warranty Period) from the date of purchase. The Warranty Period varies by region. Check with your vendor and/or the authorized ZyXEL local distributor for details about the Warranty Period of this product. During the warranty period, and upon proof of purchase, should the product have indications of failure due to faulty workmanship and/or materials, ZyXEL will, at its discretion, repair or replace the defective products or components without charge for either parts or labor, and to whatever extent it shall deem necessary to restore the product or components to proper operating condition. Any replacement will consist of a new or re-manufactured functionally equivalent product of equal or higher value, and will be solely at the discretion of ZyXEL. This warranty shall not apply if the product has been modified, misused, tampered with, damaged by an act of God, or subjected to abnormal working conditions.

Note

Repair or replacement, as provided under this warranty, is the exclusive remedy of the purchaser. This warranty is in lieu of all other warranties, express or implied, including any implied warranty of merchantability or fitness for a particular use or purpose. ZyXEL shall in no event be held liable for indirect or consequential damages of any kind to the purchaser.

To obtain the services of this warranty, contact your vendor. You may also refer to the warranty policy for the region in which you bought the device at http://www.zyxel.com/web/support_warranty_info.php.

Registration

Register your product online to receive e-mail notices of firmware upgrades and information at www.zyxel.com for global products, or at www.us.zyxel.com for North American products.

Open Source Licenses

This product contains in part some free software distributed under GPL license terms and/or GPL like licenses. Open source licenses are provided with the firmware package. You can download the latest firmware at www.zyxel.com. To obtain the source code covered under those Licenses, please contact support@zyxel.com.tw to get it.

Regulatory Information

European Union

The following information applies if you use the product within the European Union.

Declaration of Conformity with Regard to EU Directive 1999/5/EC (R&TTE Directive)

Compliance Information for 2.4GHz and 5GHz Wireless Products Relevant to the EU and Other Countries Following the EU Directive 1999/5/EC (R&TTE Directive)

[Czech]	ZyXEL tímto prohlašuje, že tento zařazení je ve shodě se základními požadavky a dalšími příslušnými ustanoveními směrnice 1999/5/EC.
[Danish]	Undertegnede ZyXEL erklærer herved, at følgende udstyr overholder de væsentlige krav og øvrige relevante krav i direktiv 1999/5/EF.
[German]	Hiermit erklärt ZyXEL, dass sich das Gerät Ausstattung in Übereinstimmung mit den grundlegenden Anforderungen und den übrigen einschlägigen Bestimmungen der Richtlinie 1999/5/EU befindet.
[Estonian]	Käesolevaga kinnitab ZyXEL seadme seadmed vastavust direktiivi 1999/5/EÜ põhinõuetele ja nimetatud direktiivist tulenevatele teistele asjakohastele sätetele.
English	Hereby, ZyXEL declares that this equipment is in compliance with the essential requirements and other relevant provisions of Directive 1999/5/EC.
[Spanish]	Por medio de la presente ZyXEL declara que el equipo cumple con los requisitos esenciales y cualesquiera otras disposiciones aplicables o exigibles de la Directiva 1999/5/CE.
[Greek]	ΜΕ ΤΗΝ ΠΑΡΟΥΣΑ ΖΥΧΕΛ ΔΗΛΩΝΕΙ ΟΤΙ ΕΞΟΠΛΙΣΜΟΣ ΣΥΜΜΟΡΦΩΝΕΤΑΙ ΠΡΟΣ ΤΙΣ ΟΥΣΙΩΔΕΙΣ ΑΠΑΙΤΗΣΕΙΣ ΚΑΙ ΤΙΣ ΛΟΙΠΕΣ ΣΧΕΤΙΚΕΣ ΔΙΑΤΑΞΕΙΣ ΤΗΣ ΟΔΗΓΙΑΣ 1999/5/ΕΚ.
[French]	Par la présente ZyXEL déclare que l'appareil équipements est conforme aux exigences essentielles et aux autres dispositions pertinentes de la directive 1999/5/EC.
[Italian]	Con la presente ZyXEL dichiara che questo attrezzatura è conforme ai requisiti essenziali ed alle altre disposizioni pertinenti stabilite dalla direttiva 1999/5/CE.
[Latvian]	Ar šo ZyXEL deklarē, ka iekārtas atbilst Direktīvas 1999/5/EK būtiskajām prasībām un citiem ar to saistītajiem noteikumiem.
[Lithuanian]	Šiuo ZyXEL deklaruoja, kad šis įranga atitinka esminius reikalavimus ir kitas 1999/5/EB Direktyvos nuostatas.
[Dutch]	Hierbij verklaart ZyXEL dat het toestel uitrusting in overeenstemming is met de essentiële eisen en de andere relevante bepalingen van richtlijn 1999/5/EC.
[Maltese]	Hawnhekk, ZyXEL, jiddikjara li dan taghmir jikkonforma mal-ħtiġijiet essenzjali u ma provvedimenti oħrajn relevanti li hemm fid-Dirrettiva 1999/5/EC.
[Hungarian]	Alulírott, ZyXEL nyilatkozom, hogy a berendezés megfelel a vonatkozó alapvető követelményeknek és az 1999/5/EK irányelv egyéb előírásainak.
[Polish]	Niniejszym ZyXEL oświadcza, że sprzęt jest zgodny z zasadniczymi wymogami oraz pozostałymi stosownymi postanowieniami Dyrektywy 1999/5/EC.
[Portuguese]	ZyXEL declara que este equipamento está conforme com os requisitos essenciais e outras disposições da Directiva 1999/5/EC.
[Slovenian]	ZyXEL izjavlja, da je ta oprema v skladu z bistvenimi zahtevami in ostalimi relevantnimi določili direktive 1999/5/EC.
[Slovak]	ZyXEL týmto vyhlasuje, že zariadenia spĺňajú základné požiadavky a všetky príslušné ustanovenia Smernice 1999/5/EC.
[Finnish]	ZyXEL vakuuttaa täten että laitteet tyyppinen laite on direktiivin 1999/5/EY oleellisten vaatimusten ja sitä koskevien direktiivin muiden ehtojen mukainen.
[Swedish]	Härmed intygar ZyXEL att denna utrustning står i överensstämmelse med de väsentliga egenskapskrav och övriga relevanta bestämmelser som framgår av direktiv 1999/5/EC.
[Bulgarian]	С настоящото ZyXEL декларира, че това оборудване е в съответствие със съществените изисквания и другите приложения разпоредбите на Директива 1999/5/EC.
[Icelandic]	Hér með lýsir, ZyXEL því yfir að þessi búnaður er í samræmi við grunnkröfur og önnur viðeigandi ákvæði tilskipunar 1999/5/EC.
[Norwegian]	Erklærer herved ZyXEL at dette utstyret er i samsvar med de grunnleggende kravene og andre relevante bestemmelser i direktiv 1999/5/EF.
[Romanian]	Prin prezenta, ZyXEL declară că acest echipament este în conformitate cu cerințele esențiale și alte prevederi relevante ale Directivei 1999/5/EC.



National Restrictions

This product may be used in all EU countries (and other countries following the EU directive 1999/5/EC) without any limitation except for the countries mentioned below:

Ce produit peut être utilisé dans tous les pays de l'UE (et dans tous les pays ayant transposés la directive 1999/5/CE) sans aucune limitation, excepté pour les pays mentionnés ci-dessous:

Questo prodotto è utilizzabile in tutte i paesi EU (ed in tutti gli altri paesi che seguono le direttive EU 1999/5/EC) senza nessuna limitazione, eccetto per i paesi menzionati di seguito:

Das Produkt kann in allen EU Staaten ohne Einschränkungen eingesetzt werden (sowie in anderen Staaten die der EU Direktive 1995/5/CE folgen) mit Ausnahme der folgenden aufgeführten Staaten:

In the majority of the EU and other European countries, the 2, 4- and 5-GHz bands have been made available for the use of wireless local area networks (LANs). Later in this document you will find an overview of countries in which additional restrictions or requirements or both are applicable.

The requirements for any country may evolve. ZyXEL recommends that you check with the local authorities for the latest status of their national regulations for both the 2,4- and 5-GHz wireless LANs.

The following countries have restrictions and/or requirements in addition to those given in the table labeled "Overview of Regulatory Requirements for Wireless LANs":.

Overview of Regulatory Requirements for Wireless LANs			
Frequency Band (MHz)	Max Power Level (EIRP) ¹ (mW)	Indoor ONLY	Indoor and Outdoor
2400-2483.5	100		V
5150-5350	200	V	
5470-5725	1000		V

Belgium

The Belgian Institute for Postal Services and Telecommunications (BIPT) must be notified of any outdoor wireless link having a range exceeding 300 meters. Please check <http://www.bipt.be> for more details.

Draadloze verbindingen voor buitengebruik en met een reikwijdte van meer dan 300 meter dienen aangemeld te worden bij het Belgisch Instituut voor postdiensten en telecommunicatie (BIPT). Zie <http://www.bipt.be> voor meer gegevens.

Les liaisons sans fil pour une utilisation en extérieur d'une distance supérieure à 300 mètres doivent être notifiées à l'Institut Belge des services Postaux et des Télécommunications (IBPT). Visitez <http://www.ibpt.be> pour de plus amples détails.

Denmark

In Denmark, the band 5150 - 5350 MHz is also allowed for outdoor usage.

I Danmark må frekvensbåndet 5150 - 5350 også anvendes udendørs.

Italy

This product meets the National Radio Interface and the requirements specified in the National Frequency Allocation Table for Italy. Unless this wireless LAN product is operating within the boundaries of the owner's property, its use requires a "general authorization." Please check <http://www.sviluppoeconomico.gov.it/> for more details.

Questo prodotto è conforme alla specifiche di Interfaccia Radio Nazionali e rispetta il Piano Nazionale di ripartizione delle frequenze in Italia. Se non viene installato all'interno del proprio fondo, l'utilizzo di prodotti Wireless LAN richiede una "Autorizzazione Generale". Consultare <http://www.sviluppoeconomico.gov.it/> per maggiori dettagli.

Latvia

The outdoor usage of the 2.4 GHz band requires an authorization from the Electronic Communications Office. Please check <http://www.esd.lv> for more details.

2.4 GHz frekvenču joslas izmantošanai ārpus telpām nepieciešama atļauja no Elektronisko sakaru direkcijas. Vairāk informācijas: <http://www.esd.lv>.

Notes:

1. Although Norway, Switzerland and Liechtenstein are not EU member states, the EU Directive 1999/5/EC has also been implemented in those countries.
2. The regulatory limits for maximum output power are specified in EIRP. The EIRP level (in dBm) of a device can be calculated by adding the gain of the antenna used (specified in dBi) to the output power available at the connector (specified in dBm).

List of national codes

COUNTRY	ISO 3166 2 LETTER CODE	COUNTRY	ISO 3166 2 LETTER CODE
Austria	AT	Malta	MT
Belgium	BE	Netherlands	NL
Cyprus	CY	Poland	PL
Czech Republic	CR	Portugal	PT
Denmark	DK	Slovakia	SK
Estonia	EE	Slovenia	SI
Finland	FI	Spain	ES
France	FR	Sweden	SE
Germany	DE	United Kingdom	GB
Greece	GR	Iceland	IS
Hungary	HU	Liechtenstein	LI
Ireland	IE	Norway	NO
Italy	IT	Switzerland	CH
Latvia	LV	Bulgaria	BG
Lithuania	LT	Romania	RO
Luxembourg	LU	Turkey	TR

Safety Warnings

- Do NOT use this product near water, for example, in a wet basement or near a swimming pool.
- Do NOT expose your device to dampness, dust or corrosive liquids.
- Do NOT store things on the device.
- Do NOT install, use, or service this device during a thunderstorm. There is a remote risk of electric shock from lightning.
- Connect ONLY suitable accessories to the device.
- Do NOT open the device or unit. Opening or removing covers can expose you to dangerous high voltage points or other risks. ONLY qualified service personnel should service or disassemble this device. Please contact your vendor for further information.
- Make sure to connect the cables to the correct ports.
- Place connecting cables carefully so that no one will step on them or stumble over them.
- Always disconnect all cables from this device before servicing or disassembling.
- Use ONLY an appropriate power adaptor or cord for your device.
- Connect the power adaptor or cord to the right supply voltage (for example, 110V AC in North America or 230V AC in Europe).
- Do NOT allow anything to rest on the power adaptor or cord and do NOT place the product where anyone can walk on the power adaptor or cord.
- Do NOT use the device if the power adaptor or cord is damaged as it might cause electrocution.
- If the power adaptor or cord is damaged, remove it from the power outlet.
- Do NOT attempt to repair the power adaptor or cord. Contact your local vendor to order a new one.
- Do not use the device outside, and make sure all the connections are indoors. There is a remote risk of electric shock from lightning.
- Do NOT obstruct the device ventilation slots, as insufficient airflow may harm your device.
- If you wall mount your device, make sure that no electrical lines, gas or water pipes will be damaged.
- This power unit is intended to be correctly orientated in a vertical or floor mount position.

Your product is marked with this symbol, which is known as the WEEE mark. WEEE stands for Waste Electronics and Electrical Equipment. It means that used electrical and electronic products should not be mixed with general waste. Used electrical and electronic equipment should be treated separately.



Index

Symbols

.NET Framework [23](#)

A

about screen [35](#)

Advanced Encryption Standard, see AES [9](#)

AES [11, 27](#)

AES (Advanced Encryption Standard) [9](#)

applications [9](#)

C

certifications [115](#)

notices [116](#)

viewing [116](#)

channel [64](#)

Configuration

restore [92](#)

configuration screen [29](#)

connections overview [9](#)

copyright [115](#)

CPU usage [56](#)

D

DAK [27, 29](#)

DAK (Data Access Password) [11](#)

Data Access Password, see DAK [11](#)

Daylight saving [90](#)

disclaimer [115](#)

documentation

related [2](#)

E

electrical and cable wiring [27](#)

electrical circuit boundaries [27](#)

encryption [9, 27, 65](#)

key [65](#)

WPA compatible [65](#)

ESSID [100](#)

ETHN LED [95](#)

F

FCC interference statement [115](#)

firmware [30](#)

Firmware upload [90](#)

file extension

using HTTP

firmware version [56](#)

G

General wireless LAN screen [66](#)

Guide

Quick Start [2](#)

H

HomePlug [83](#)

HomePlug AV standard [9](#)

I

installation

overview [23](#)

procedure [23](#)

- requirements [23](#)
- InstallShield wizard [24](#)
- introduction [9](#)
- IP Address [82](#)
- IP alias [80](#)

L

- LAN [79](#)
- LAN overview [79](#)
- LAN setup [79](#)
- LAN TCP/IP [80](#)
- Language [93](#)
- LED [95](#)
 - ETHN [95](#)
 - LINK [95](#)
 - PWR [95](#)
- LINK LED [95](#)
- Link type [56](#)
- Local Area Network [79](#)
- local vs. remote adapter [29](#)
- Log [59](#)

M

- MAC [71](#)
- MAC address [29, 64](#)
- MAC address filter [64](#)
- MAC address filtering [71](#)
- MAC filter [71](#)
- management
 - multiple networks [11](#)
 - overview [27](#)
- managing the device
 - good habits [10](#)
 - using the web configurator. See web configurator.
- Media access control [71](#)
- Memory usage [56](#)
- multiple networks [12](#)

N

- network example [27](#)
- network information [31](#)

O

- Operating Channel [56](#)
- other documentation [2](#)

P

- Parameter Information Block, see PIB [30](#)
- passwords [27, 29, 30, 84](#)
 - types of [11](#)
- PIB (Parameter Information Block) [30](#)
- plug-and-play [27](#)
- port speed [57](#)
- powerline setting [83](#)
- priority settings [32](#)
 - application type [33](#)
 - priority levels [34](#)
- private network [11](#)
- problems and solutions [95](#)
- product registration [116](#)
- PWR LED [95](#)

Q

- Quality of Service (QoS) [73](#)
- Quick Start Guide [2](#)

R

- receive rate [31](#)
- registration
 - product [116](#)
- related documentation [2](#)
- Reset button [12](#)

Reset the device [12](#)
Restore configuration [92](#)
Roaming [73](#)
RTS/CTS Threshold [64, 73](#)

S

Scheduling [76](#)
security [10, 11, 27](#)
 passwords [11](#)
Service Set [66](#)
Service Set IDentification [66](#)
Service Set IDentity. See SSID.
SSID [56, 64, 66](#)
starting the utility [28](#)
Status Screens [55](#)
 Ethernet [55](#)
 system statistics [55](#)
 WLAN [55](#)
Subnet Mask [82](#)
Summary
 Packet statistics [60](#)
 Wireless station status [61](#)
System General Setup [87](#)
System restart [93](#)

T

Time setting [88](#)
trademarks [115](#)
transfer rates [9](#)
transmit rate [31](#)
troubleshooting [95](#)

U

utility
 launching [28](#)

W

warranty [116](#)
 note [116](#)
Web Configurator
 how to access [49](#)
 Overview [49](#)
web configurator [10](#)
WEP Encryption [69, 71](#)
WEP encryption [68](#)
WEP key [68](#)
Wi-Fi Protected Setup [13](#)
Wireless association list [61](#)
wireless channel [100](#)
wireless LAN [100](#)
wireless LAN scheduling [76](#)
Wireless network
 basic guidelines [63](#)
 channel [64](#)
 encryption [65](#)
 example [63](#)
 MAC address filter [64](#)
 overview [63](#)
 security [64](#)
 SSID [64](#)
Wireless security [64](#)
 overview [64](#)
 type [64](#)
wireless security [100](#)
WPA compatible [65](#)
WPS [13](#)
WPS button [13](#)

